



Data Acquisition DigiRail



Introduction



The DigiRail line of smart transmitters with Modbus RTU communication interface provide a simple way for integrating analog or digital signals to supervisory systems. Featuring up to two universal input analog signal channels they are the most economical way to deliver analog inputs to PLC's and SCADA systems.

The input signals are isolated from power thus protecting the electrical instruments by eliminating ground loop effects. This reduces substantially the undesirable interferences and instabilities in sensor measurements.

DigiRail can be easily configured and calibrated via the digital interface by using the Windows based Digiconfig software.

The DigiRail line of transmitters complies 3 models, according to their input or output types:

- DigiRail-1A and DigiRail-2A, with 1 or 2 universal analog inputs respectively
- DigiRail-4C, with 4 digital counters
- DigiRail-2R, with 2 timer relay outputs

Specifications



Model 2A

- Analog inputs: programmable for thermocouples (J, K, T, E, N, R, S, B), Pt100, mV, V, mA. Refer to table 1
- Cold junction compensation for thermocouples and compensation for Pt100 3-wire cables
- Open loop detection for thermocouples, Pt100 and mV
- Sampling rate for 1 analog input: 10 Hz for mV, V and mA. 5Hz for t thermocouples and Pt100
- Analog input resolution: 17 bits
- Accuracy (at 25°C): Pt100, mV, V and mA: $\pm 0.15\%$ of full scale. Thermocouples: $\pm 0.25\%$ of full scale
- Temperature effect: 0.003% of full scale/°C
- Cold junction compensation for thermocouples: $\pm 1^\circ\text{C}$ at 25°C $\pm 0.05^\circ\text{C}/^\circ\text{C}$
- Isolation: 1000 Vac from inputs (analog or digital) and power or communication. Communication and power are not isolated from one another nor are the analog inputs from each other. Every two digital inputs are isolated from other pairs of same inputs

Model 4C

- Input voltage level: Low level: 0 to 1 Vdc. High level: 4 to 35 Vdc. Internal current restricted to 5 mA
- Input Maximum Frequency: 1 KHz / duty cycle 50%. Input 1 compatible with up to 100 KHz signal

- Pulse counter (32 bits): 0 to 4.294.967.295)
- Pulse countdown capacity for periodical time lapse and pulsed retention in time lapse (peak)
- Isolation: 1000 Vdc from inputs and power or communication. Communication and power are not isolated. Digital inputs isolated from each other per pairs

Model 2R

- Digital outputs: 8 A / 250 Vac SPDT relay, resistive load
- Output timing
- Bounce time (NO / NC): 3 / 6 ms
- Isolation: 2000 Vac from outputs and power or communication

All Models

- Power: 10 to 35 Vdc, 50 mA maximum current
- 2-wire RS485 communication with Modbus RTU protocol Configurable address and baud rate (1,200 to 115,200 bps)
- LED indicators for communication and status. Key for resetting communication parameters to original factory default
- Windows based configurator software
- Dimensions: 72 x 78 x 19 mm
- Mounting: 35mm DIN rail
- Working temperature: 0 to 70 C

Electrical Connections

DigiRail - 2A
Analog Inputs

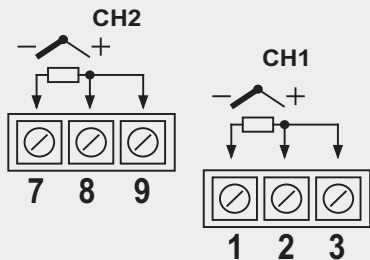

DigiRail - 4C
Digital Inputs

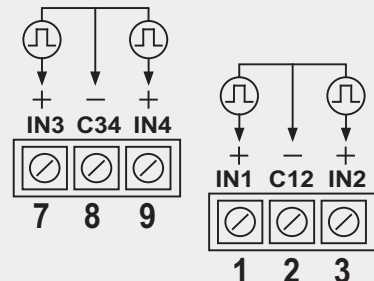

DigiRail - 2R
Relay Outputs

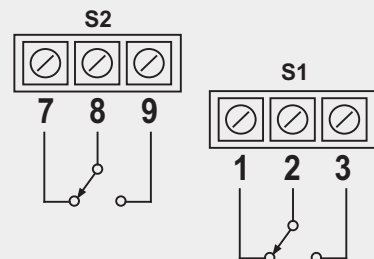

Communication and Power
(for all models)

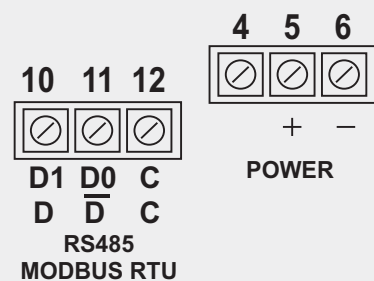

Obs.: Terminals 6 and 12 are connected internally.

Dimensions

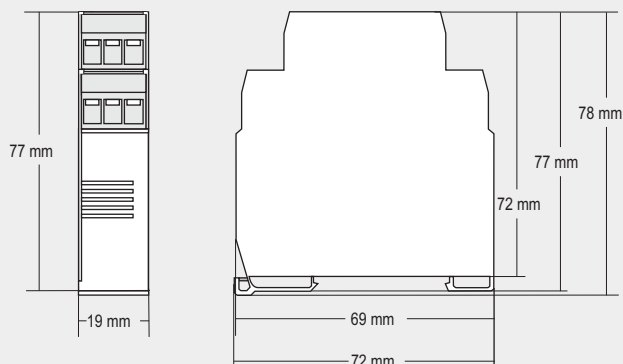

Configuration

DigiRail Configuration is done via the RS485 interface by using Modbus RTU commands.

The DigiConfig software allows for configuration of all DigiRail features as well as complete calibration and diagnosis. It automatically detects active devices in the Modbus network and permits configuration of all parameters.

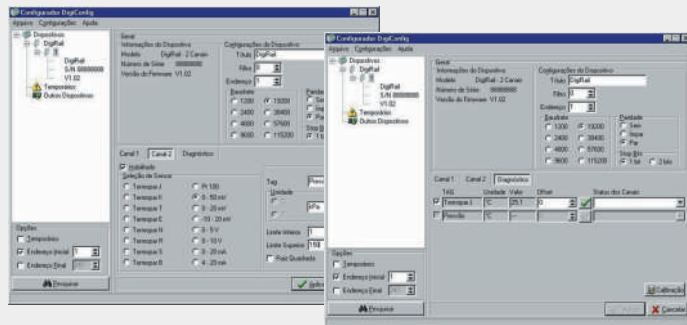

Block Diagrams

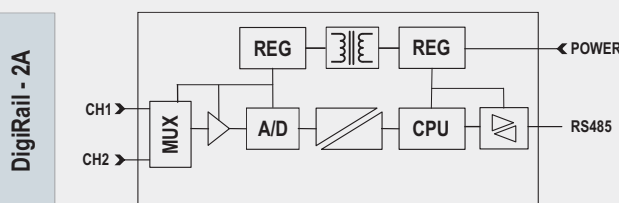
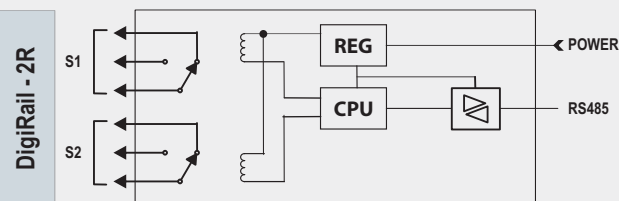
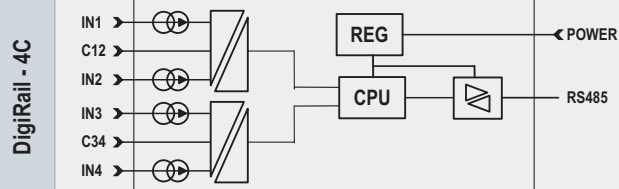

Input Types and Maximum Ranges (DigiRail-2A)

INPUT	MEASURING RANGE
Thermocouple J	-130 to 940 °C / -202 to 1724 °F
Thermocouple K	-200 to 1370 °C / -328 to 2498 °F
Thermocouple T	-200 to 400 °C / -328 to 752 °F
Thermocouple E	-100 to 720 °C / -148 to 1328 °F
Thermocouple N	-200 to 1300 °C / -328 to 2372 °F
Thermocouple R	0 to 1760 °C / 32 to 3200 °F
Thermocouple S	0 to 1760 °C / 32 to 3200 °F
Thermocouple B	500 to 1800 °C / 932 to 3272 °F
Pt100	-200 to 650 °C / -328 to 1202 °F
0 to 50 mV	Measuring range and engineering units are user configurable.
0 to 20 mV	
-10 to 20 mV	
0 to 5 V	
0 to 10 V	
0 to 20 mA	
4 to 20 mA	