



N1040i Indicator

UNIVERSAL INDICATOR – INSTRUCTIONS MANUAL – V1.0x D

PRESENTATION

N1040i is a quite versatile process indicator. With a wide list of input types - thermocouples, thermo-resistance, voltage and current – the N1040i is capable of measuring the majority of the variables and sensors encountered in industrial processes.

It also features various alarm functions, display offset, configuration with password protection, serial communication, indication in degrees Celsius (°C) or Fahrenheit (°F), among others.

FEATURES

SIGNAL INPUT (INPUT)

The input type to be used by the indicator is defined in the equipment configuration. Table 01 presents the input options available for the user.

| TYPE | CODE | RANGE OF MEASUREMENT |
|--------------------------|--------------|---|
| J | tc J | Range: -110 to 950 °C (-166 to 1742 °F) |
| K | tc P | Range: -150 to 1370 °C (-238 to 2498 °F) |
| T | tc t | Range: -160 to 400 °C (-256 to 752 °F) |
| N | tc n | Range: -270 to 1300 °C (-454 to 2372 °F) |
| R | tc r | Range: -50 to 1760 °C (-58 to 3200 °F) |
| S | tc S | Range: -50 to 1760 °C (-58 to 3200 °F) |
| B | tc b | Range: 400 to 1800 °C (752 to 3272 °F) |
| E | tc E | Range: -90 to 730 °C (-130 to 1346 °F) |
| Pt100 | Pt | Range: -200 to 850 °C (-328 to 1562 °F) |
| 0-20 mA | L0.20 | Analog Linear Signal Indication programmable from -1999 to 9999. |
| 4-20 mA | L4.20 | |
| 0-50 mV | L0.50 | |
| 0-5 Vdc | L0.5 | |
| 0-10 Vdc | L0.10 | |
| 4-20 mA NON LINEAR | Ln J | Non Linear Analog Signal Indication range according to the associated sensor. |
| | Ln P | |
| | Ln t | |
| | Ln n | |
| | Ln r | |
| | Ln S | |
| | Ln b | |
| | Ln E | |
| | LnPt | |

Table 01 – Inputs Types

ALARMS

The 1040i can have none, one or two alarms. Each alarm present is associated to one output with the same name (ALARM1 and ALARM2).

OUTPUT ALARM1 - Relay SPDT. Available in terminals 10, 11 and 12 of the indicator.

OUTPUT ALARM2 - Relay SPST-NA. Available in terminals 13 and 14 of the indicator.

The alarms can assume the functions described on Table 02.

| | | |
|--------------|---|--|
| oFF | Alarm off. | |
| Lo | Alarm of the Absolute Minimum Value. It triggers when the value of the PV is below the value defined by the alarm Setpoint (SPA1 or SPA2). | |
| Hi | Alarm of the Absolute Maximum Value. It triggers when the value of the PV is above the value defined by the alarm Setpoint. | |
| d iF | Alarm of the Differential Value. In this function the parameters "SPA1" and "SPA2" represent errors (difference) between the PV and one reference value ALrF. | |
| | | |
| d iFL | Alarm of the Minimum Differential Value. It triggers when the value of the PV is below the point defined by: ALrF-SPA1 (using alarm 1 as an example). | |
| | | |
| d iFH | Alarm of the Maximum Differential Value. It triggers when the value of the PV is above the point defined by: ALrF+SPA1 (using alarm 1 as an example). | |
| | | |
| iErr | Alarms of the Sensor Break (Sensor Break Alarm). It is activated when the Input presents problems such as interrupted sensor, bad connection, etc. | |

Table 02 – Alarm Functions

Note: The figures are also valid for Alarm 2 (SPA2).

BLOCKING INITIAL OF THE ALARM

The initial blocking option inhibits the alarm from being recognized if an alarm condition is present in the process when the indicator is first energized. The alarm will be enabled only after the occurrence of no alarm condition.

The initial blocking is useful, for example, when one of the alarms is set up as a minimum value alarm, which may cause the activation of the alarm soon upon the process start-up; an occurrence that may undesirable in many cases.

The initial blocking is not valid for the function **IErr** (Sensor Break).

OFFSET

Allows the user to perform fine adjustments to the PV indication. It allows the correction of measuring errors that appear, for example, on the replacement of the temperature sensor.

RETRANSMISSION OF PV

The indicator may include an analog output which performs the retransmission of the values of PV into a signal of 0-20 mA or 4-20 mA. The analog retransmission can be scaled, i.e., there are minimum and maximum limits to establish the retransmission range, defined in the parameters **"rLlL"** and **"rLhL"**.

The analog output is available on terminals 13 and 14 for models **N1040i-RA** and **N1040i-RA-485**.

In order to obtain retransmission in electrical voltage, the user shall install a *shunt* resistor (500 Ω max.) across the analog output terminals. This resistor value depends on the desired voltage range.

The analog retransmission output is not electrically isolated from the RS485 serial communication.

24 Vdc AUXILIARY VOLTAGE SOURCE

Another feature that may be available in the indicator is an auxiliary power supply for exciting field transmitters (two-wire 4-20 mA transmitters).

The 24 Vdc output is on terminals 13 and 14 for models **N1040i-RE** and **N1040i-RE-485**.

The 24 V auxiliary power supply is not electrically isolated from the RS485 serial communication.



INSTALLATION / CONNECTIONS

The indicator shall be fastened on a panel, following the sequence of steps described below:

- Prepare a cut-out of 46 x 46 mm on the panel;
- Remove the mounting clamp from the indicator;
- Insert the indicator into the cut-out from the front side of the panel;
- Place the clamp on the indicator again, pressing until firm grip to the panel.

SAFETY ALERTS

The symbols below are used on the equipment and throughout this manual in order to draw the user's attention to important information related to the equipment safety and operation.

| | |
|---|---|
|  |  |
| CAUTION: Read the manual thoroughly before installing and operating the equipment | CAUTION OR DANGER: Electrical shock hazard |

All safety related instructions that appear in the manual must be observed to ensure personal safety and to prevent damage to either the instrument or the system. If the instrument is used in a manner not specified by the manufacturer, the protection provided by the equipment may be impaired.

ELECTRICAL CONNECTIONS

The position of the features on the indicator back panel is shown on **Figure 01**:

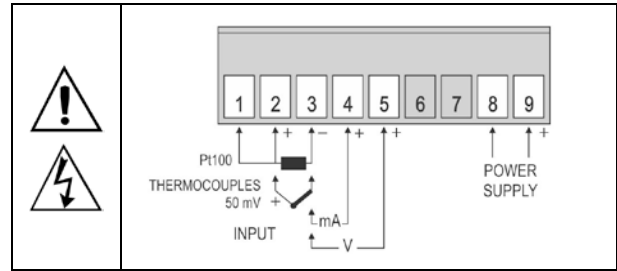

Figure 01 – Inputs connections and power supply

In the models with two alarms and serial communication, the connections are:

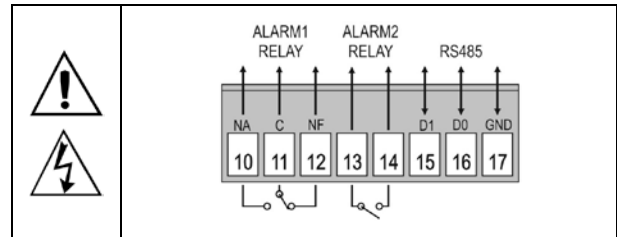

Figure 02 - Alarms and serial communication connections

In the models with one alarm, retransmission of PV and serial communication, the connections are:

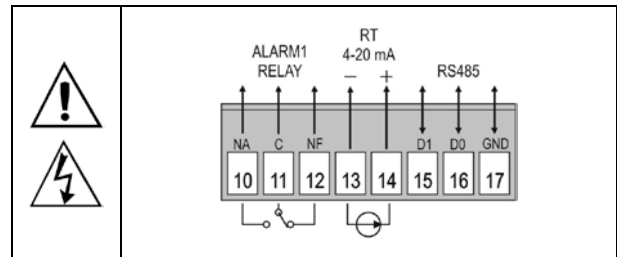

Figure 03 - Alarm, retransmission and serial communication connections

In the models with one alarm, 24 Vdc auxiliary voltage source and communication, the connections are:

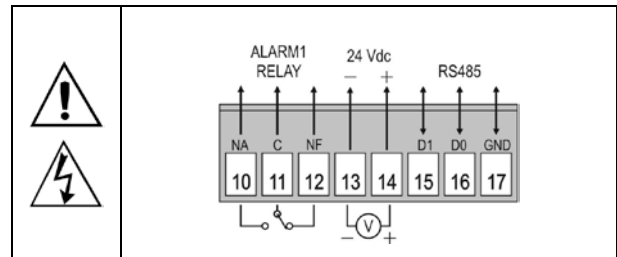

Figure 04 - Alarm, auxiliary source and communication connections

A typical application of the auxiliary voltage source is to supply loop power for field transmitters (two-wire 4-20 mA). **Figure 05** shows the necessary wiring for this application.

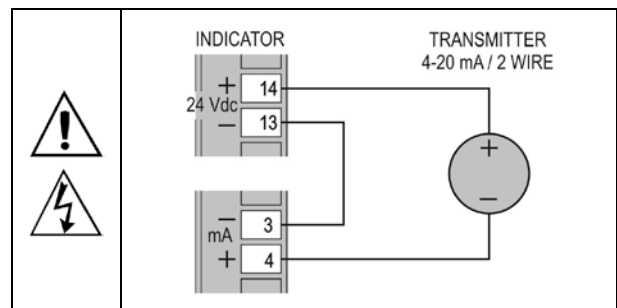

Figure 05 – Example for the use of the indicator auxiliary voltage source

RECOMMENDATIONS FOR THE INSTALLATION

- To minimize the pick-up of electrical noise, the low voltage DC connections and the sensor input wiring should be routed away from high-current power conductors. If this is impractical, use shielded cables. In general, keep cable lengths to a minimum.
- The input signals conductors shall be positioned throughout the factory separate from the output and the power supply conductors, in grounded conduits if possible.
- The power supply of the electronic instruments shall come from a proper source for the instrumentation network.
- It is recommended to use RC FILTERS (0.1 uF in series with 100 ohms) to suppress the noise generated by contactors coils, solenoids, etc.

OPERATION

The indicator front panel, together with its elements, can be seen on Figure 06:



Figure 06 - Identification of the front panel parts

Display: Shows the process variable PV, the configuration parameters prompts and their respective values/ conditions.

Indicators A1 and A2: signalize the occurrence of an alarm condition.

Key P: used to walk through the parameters in the menu cycles.

▲ Increment key and ▼ Decrement key: Used to change parameter values.

◀ Key: A key used to retrocede to the previous displayed parameter.

START UP

When the controller is powered up, its firmware version is displayed for 3 seconds, after which the N1540 starts normal operation, when the value of PV is displayed and the outputs are enabled.

Before the indicator is ready to be used in a given process, it requires some basic configuration, consisting of assigning values to the parameters according to the desired behavior. The user shall understand the importance of each parameter and determine a valid condition or a valid value for each one of them.

The configuration parameters are grouped in parameters levels according to their functionalities. The 4 parameters levels are:

- 1 – Operation
- 2 – Alarms
- 3 – Input
- 4 – Calibration

The “P” key provides the access to the levels and to the parameters of these levels.

Keeping the P key pressed, at every 2 seconds, the indicator jumps from one level to another, presenting the first parameter of each level:

PV >> FuA1 >> tYPE >> PASS >> PV ...

To enter into a particular level, simply release the P key when the first parameter in that level is displayed.

To walk through the parameters in a level, press the P key with short strokes. To go back to the previous parameters, use the ◀ Key.

Each parameter symbol is shown on the upper display while its respective value/condition is shown on the lower display.

Depending on the level of parameter protection adopted, the parameter PASS precedes the first parameter in the level where the protection is active. See section PROTECTION CONFIGURATION.

DESCRIPTION OF THE PARAMETERS

OPERATION CYCLE

| | |
|---|---|
| PV | Indication Display of PV. The value of the measured variable (PV) is shown on the upper display (red). |
| SPA1 SPA2 <i>SetPoint Alarm</i> | Alarm SP: Value that defines the alarm activation point. For the alarms set up with the functions of the type Differential , these parameters define the maximum differences accepted between PV or a reference value defined in the parameter ALrF . For the alarm function IErr , this parameter is not used. Parameters shown in this level only when enabled in the parameters SP1E and SP2E . |

ALARMS CYCLE

| | |
|--|--|
| FuA1 FuA2 <i>Function Alarm</i> | Alarm Functions. It defines the functions of the alarms among the options in Table 02. |
| ALrF <i>Alarm Reference</i> | Reference value used by the alarms with differential function, minimum differential or maximum differential. |
| SPA1 SPA2 <i>SetPoint Alarm</i> | Alarm SP: Value that defines the point of activation of the alarm outputs. For the alarms programmed with the functions of the type Differential , these parameters represent the deviations. For the IErr alarm function, this parameter has no meaning. |
| SP1E SP2E <i>SP Enable</i> | It allows the display of the parameters SPA1 and SPA2 also in the indicator operation cycle. YES shows the parameters SPA1/SPA2 in the operation cycle no DOES NOT show the parameters SPA1/SPA2 in the operation cycle |
| bLA1 bLA2 <i>Blocking Alarm</i> | Alarms Initial Blocking. YES enables the initial blocking no inhibits the initial blocking |
| HYA1 HYA2 <i>Hysteresis of Alarm</i> | Alarm Hysteresis. It defines the difference between the value of PV at which the alarm is triggered and the value at which it is turned off. |
| FLSh <i>Flash</i> | It allows signalization of an alarm conditions occurrence by flashing the indication of PV on the indication display. YES Enables alarm signalization by flashing PV. no Does not enable alarm signalization by flashing PV. |

INPUT CYCLE

| | |
|-------------------------------------|--|
| tYPE <i>Type</i> | Input Type. Selection of the input type, used by the indicator. Refer to Table 01. |
| FLtr <i>Filter</i> | Digital Input Filter – Used to improve the stability of the measured signal (PV). Adjustable between 0 and 20. At 0 (zero) it means filter turned off and 20 means maximum filter. The higher the filter value, the slower is the response of the measured value. |
| dPPo <i>Decimal Point</i> | It determines the position of the decimal point on the display. |
| un t <i>Unit</i> | It defines the temperature unit to be used: C indication in Celsius. F indication in Fahrenheit. |

| | |
|---|---|
| OFFS <i>Offset</i> | Parameter that allows the user to make corrections in the value of PV indicated. |
| InLL <i>Input Low Limit</i> | It defines the <u>lower</u> value of the indication range when the input types of 0-20 mA, 4-20 mA, 0-50 mV, 0-5 V and 0-10 V are used. |
| InHL <i>Input High Limit</i> | It defines the <u>upper</u> value of the indication range when the input types of 0-20 mA, 4-20 mA, 0-50 mV, 0-5 V and 0-10 V are used. |
| rEtr <i>Retransmission</i> | It allows the definition of the mode of retransmission of PV. P020 Determines retransmission in 0-20 mA. P420 Determines retransmission in 4-20 mA. Parameter shown when there is retransmission of PV available on the indicator. |
| rELL <i>Retransmission Low Limit</i> | It defines the <u>lower</u> limit of the retransmission range of PV. Parameter shown there is retransmission of PV available on the indicator. |
| rEHL <i>Retransmission High Limit</i> | It defines the <u>upper</u> limit of the retransmission range of PV. Parameter shown there is retransmission of PV available on the indicator. |
| bAud <i>Baud Rate</i> | Baud Rate of the serial communication. In kbps. 1.2, 2.4, 4.8, 9.6, 19.2, 38.4, 57.6 and 115.2 |
| PrEY <i>Parity</i> | Parity of the serial communication. nonE Without parity EuEn Even parity Odd Odd parity |
| Addr <i>Address</i> | Communication Address. A number that identifies the indicator in the serial communication network, between 1 and 247. |

CALIBRATION CYCLE

All types of input are calibrated in the factory. In case a recalibration is required; it shall be carried out by a specialized professional. In case this cycle is accidentally accessed, do not perform alteration in its parameters. The factory calibration can be restored in the parameter **rSEr**.

| | |
|---------------|--|
| PASS | <u>Password</u> . Entering the Access password. This parameter is presented before the protected cycles. See item Protection of Configuration. |
| CAL Ib | <u>Calibration</u> . Enables the possibility for calibration of the indicator. When the calibration is not enabled, the related parameters are hidden. |
| InLC | <u>Input Low Calibration</u> . Indication of the low scale calibration signal applied to the input. |
| InHC | <u>Input High Calibration</u> . Indication of the full scale calibration signal applied to the input. |
| ouLC | <u>Output Low Calibration</u> . Enter the analog value as measured at the analog output. |
| ouHC | <u>Input High Calibration</u> . Enter the analog value as measured at the analog output. |
| rSEr | <u>Restore</u> . It restores the factory calibrations of the input, disregarding any modifications carried out by the user. |
| CJ | <u>Cold Junction</u> . Temperature of the indicator cold junction. |
| PASC | <u>Password Change</u> . It allows the definition of a new access password, always different from zero. |
| Prot | <u>Protection</u> . Sets up the Level of Protection. See Table 03. |
| FrE9 | <u>Frequency</u> . Frequency of the local electrical network. |

CONFIGURATION PROTECTION

The indicator allows the protection of the configuration performed by the user, not allowing improper modifications. The parameter **Protection (Prot)**, in the Calibration level, determines the protection strategy to be adopted, limiting the access to the levels, according to the table below.

| Protection Level | Protected Levels |
|------------------|---|
| 1 | Only the Calibration level is protected. |
| 2 | Input and Calibration levels are protected. |
| 3 | Alarms, Input and Calibration levels are protected. |

Table 03 – Levels of Protection of the Configuration

ACCESS PASSWORD

The protected levels, when accessed, request the user to provide the **Access Password** for granting permission to change the configuration of the parameters on these levels.

The prompt **PASS** precedes the parameters on the protected levels. If no password is entered, the parameters of the protected levels can only be visualized.

The Access Password is defined by the user in the parameter **Password Change (PASC)**, present in the Calibration Level. The factory default for the password code is 1111.

PROTECTION OF THE ACCESS PASSWORD

The protection system built into the controller blocks for 10 minutes the access to protected parameters after 5 consecutive frustrated attempts of guessing the correct password.

MASTER PASSWORD

The Master Password is intended for allowing the user to define a new password in the event of it being forgotten. The Master Password doesn't grant access to all parameters, only to the **Password Change** parameter (**PASC**). After defining the new password, the protected parameters may be accessed (and modified) using this new password.

The master password is made up by the last three digits of the serial number of the controller **added** to the number 9000.

As an example, for the equipment with serial number 07154321, the master password is 9 3 2 1.

The indicator serial number can be obtained by pressing **◀** for 5 seconds.

MAINTENANCE

PROBLEMS WITH THE INDICATOR

Connection errors and inadequate programming are the most common problems encountered during the indicator operation. A final revision can avoid loss of time and damages.

The indicator displays some messages to help the user identify the problems.

| MESSAGE | DESCRIPTION OF THE PROBLEM |
|------------------------------|--|
| ---- | Open input. Without sensor or signal. |
| Err 1 Err 6 | Connection and/ or configuration problems. Check the wiring and the configuration. |

Other error messages may indicate hardware problems requiring maintenance service. When contacting the manufacturer, inform the instrument serial number, obtained by pressing the key **◀** for more than 3 seconds.

INPUT CALIBRATION

All inputs are factory calibrated and recalibration should only be done by qualified personnel. If you are not familiar with these procedures do not attempt to calibrate this instrument.

The calibration steps are:

- a) Configure the type of input to be calibrated.
- b) Configure the lower and upper limits of indication for the maximum span of the selected input type.
- c) At the input terminals inject a signal corresponding to a known indication value a little above the lower display limit.
- d) Access the parameter "InLC". With the keys \blacktriangle and \blacktriangledown , adjust the display reading such as to match the applied signal. Then press the \blacksquare key.
- e) Inject a signal that corresponds to a value a little lower than the upper limit of indication.
- f) Access the parameter "InHC". With the keys \blacktriangle and \blacktriangledown , adjust the display reading such as to match the applied signal. Then press the \blacksquare key.

Note: When checking the indicator calibration with a Pt100 simulator, pay attention to the simulator minimum excitation current requirement, which may not be compatible with the 0.170 mA excitation current provided by the indicator.

ANALOG OUTPUT CALIBRATION

1. Configure analog input for 0-20 mA retransmission ($rEtr = P020$).
2. Attach a milliamp meter to terminals 13 and 14.
3. Enter Calibration Cycle.
4. Access "ouLC" calibration parameter and press \blacktriangle followed by \blacktriangledown .
5. Using \blacktriangle or \blacktriangledown Keys, set "ouLC" parameter to the same value read in the milliamp meter
6. Access "ouHC" calibration parameter and press \blacktriangle followed by \blacktriangledown .
7. Using \blacktriangle or \blacktriangledown Keys, set "ouHC" parameter to the same value read in the milliamp meter.
8. Exit Calibration Cycle.

SPECIFICATIONS



DIMENSIONS:48 x 48 x 80 mm
 Approximate Weight: 75 g
POWER SUPPLY:.....100 to 240 Vac ($\pm 10\%$), 50/60 Hz
 Optional 24 V12 a 24 Vdc / 24 Vac (-10% / $+20\%$)
 24 to 240 Vdc ($\pm 10\%$) for model N1040i-F
 Maximum consumption:..... 6 VA

ENVIRONMENTAL CONDITIONS:

Operation Temperature: 0 to 50 °C
 Relative Humidity:.....80 % @ 30 °C
 For temperatures above 30 °C, reduce 3 % per °C
 Indoor use; Installation Category II, Pollution Degree 2; altitude < 2000 meters

INPUTAccording to **Table 01**

Internal Resolution:..... 32767 levels (15 bits)
 Display Resolution:.....0.1 / 1 (°C / °F)
 Input reading rate: up to 55 per second
 Precision @ 25 °C:..... J, K, T, E: 0.25 % of the span ± 0.1 °C / °F
 N, R, S, B: 0.25 % of the span ± 1 °C / °F
 Pt100: 0.2 % of the span
 4-20 mA, 0-50 mV, 0-5 V, 0-10 V: 0.2 % of the span
 Input impedance: Pt100, thermocouples, 0-50 mV: > 10 M Ω
 0-5 V, 0-10 V: > 500 k Ω
 4-20 mA: 100 Ω
 Measuring of the Pt100:3 wire type, ($\alpha=0.00385$)
 With compensation of the cable length, max 50 meters, excitation current of 0.170 mA.

OUTPUT ALARM1:.....Relay SPDT; 240 Vac / 30 Vdc / 3 A
OUTPUT ALARM2:.....Relay SPST-NA; 240 Vac / 30 Vdc / 1,5 A
RETRANSMISSION OF PV:
 0-20 mA / 4-20 mA / 500 Ω max. / 12.000 levels
24 Vdc SOURCE: 24 Vdc ($\pm 10\%$) / 20 mA max.
CASE: Polycarbonate (PC) UL94 V-2
BACK PANEL:ABS+PC UL94 V-0
ELECTROMAGNETIC COMPATIBILITY:..... EN 61326-1:1997 and EN 61326-1/A1:1998
SAFETY: EN61010-1:1993 and EN61010-1/A2:1995
ADEQUATE CONNECTIONS FOR TERMINALS OF THE CLAMP TYPE;
STARTS OPERATION: after 3 seconds connected to the power supply;
CERTIFICATIONS:  and  us.

IDENTIFICATION

| | | | |
|----------|-----|-----|---|
| N1040i - | A - | B - | C |
|----------|-----|-----|---|

- A: Outputs Features
 - RR 2 relays available (ALARM1 / ALARM2)
 - RA 1 relay and one analog output 0-20 / 4-20 mA
 - RE 1 relay and one auxiliary 24 Vdc voltage source
- B: Digital Communication
 - 485 RS485 available
- C: Power Supply Features (POWER)
 - Blank 100 a 240 Vac/dc
 - 24V 12 a 24 Vdc / 24 Vac
 - F 24 a 240 Vac/dc

SAFETY INFORMATION

Any control system design should take into account that any part of the system has the potential to fail. This product is not a protection or safety device and its alarms are not intended to protect against product failures. Independent safety devices should be always provided if personnel or property are at risk.

Product performance and specifications may be affected by its environment and installation. It's user's responsibility to assure proper grounding, shielding, cable routing and electrical noise filtering, in accordance with local regulations, EMC standards and good installation practices.

APPENDIX 1 - SERIAL COMMUNICATION

The indicator may be supplied with an asynchronous serial communication RS-485 interface, with a master-slave connection for communication with a host computer (master). The indicator is always the slave. The communication is always initiated by the master, which sends a command to the slave address with which to communicate. The addressed slave recognizes the command and sends a response to the master. The indicator also accepts broadcast commands.

CHARACTERISTICS

- Signals compatible with RS-485 standard. MODBUS (RTU) Protocol. Two wire connection between 1 master and up to 31 (addressing up to 247 possible) instruments in bus topology.
- Communication signals are electrically isolated from the INPUT and POWER terminals. Not isolated from the retransmission circuit and the auxiliary voltage source when available.
- Maximum connection distance: 1000 meters.
- Time of disconnection for the controller: Maximum 2 ms after last byte.
- Programmable baud rate: 1200 to 115200 bps.
- Data Bits: 8
- Parity: Even, Odd or None
- Stop bits: 1
- Time at the beginning of response transmission: maximum 100 ms after receiving the command.

The RS-485 signals are:

| | |
|-----|---|
| D0 | Bi-directional inverted data line. Other names: DI, D- or A |
| D1 | Bi-directional data line. Other names: D, D+ or B |
| GND | Optional connection that improves the performance of the communication. |

CONFIGURATION OF SERIAL COMMUNICATION PARAMETERS

Three parameters must be configured in the device for serial communication:

bAud: Communication speed.

Prty: Parity of the communication.

Addr: Communication address for the indicator.