

Controller N1100

UNIVERSAL PROCESS CONTROLLER – INSTRUCTIONS MANUAL V2.1x



PRESENTATION

The N1100 is a process controller incorporating a PID algorithm and universal inputs (sensor and standard signals) and outputs (logical, relay and analog outputs). It holds in one single instrument all the main features that are needed for the vast majority of industrial processes.

SAFETY SUMMARY

The symbols below are used on the equipment and throughout this document to draw the user's attention to important operational and safety information.

CAUTION or WARNING: Read complete instructions prior to installation and operation of the unit.	CAUTION or WARNING: Electrical Shock Hazard

All safety related instructions that appear in the manual must be observed to ensure personal safety and to prevent damage to either the instrument or the system. *If the instrument is used in a manner not specified by the manufacturer, the protection provided by the equipment may be impaired.*

OVER-TEMPERATURE PROTECTION

When designing any control system it is essential to consider what will happen if any part of the system should fail. In temperature control applications the primary danger is one in which the heating remains constantly on. In any application where physical injury or destruction of equipment might occur, it is recommended to install an independent protection equipment, with a separate temperature sensor, to disable the heating circuit in case of overheating. Please note that the alarm relays within the controller will not give protection under all failure conditions.

INSTALLATION

Insert the unit into the panel cut-out and slide the mounting clamp from the rear to a firm grip at the panel.

ELECTRICAL CONNECTIONS

All electrical connections are made to the screw terminals at the rear of the controller. They accept wire sizes from 0.5 to 1.5 mm² (16 to 22 AWG). The terminals should be tightened to a torque of 0.4 Nm (3.5 lb in).

To minimize the pick-up of electrical noise, the low voltage DC connections and the sensor input wiring should be routed away from high-current power conductors. If this is impractical, use shielded cables. In general, keep cable lengths to a minimum.

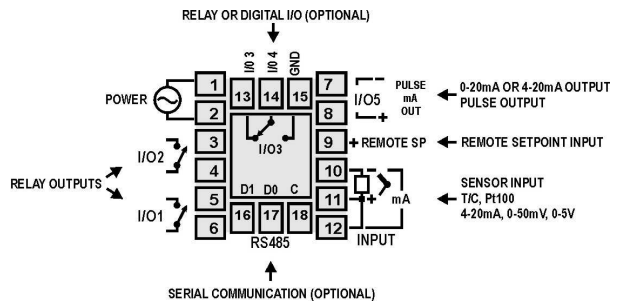

Figure 1 - Backpanel terminals

• Power Wiring

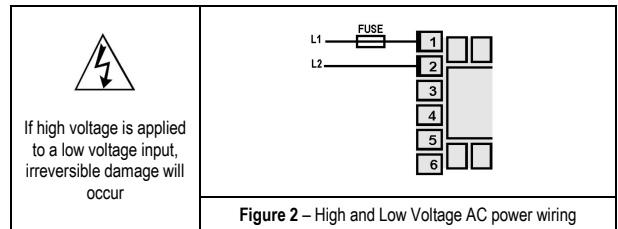

Figure 2 – High and Low Voltage AC power wiring

• Thermocouple and Voltage (Volts and mV) input connect as in Figure 3.

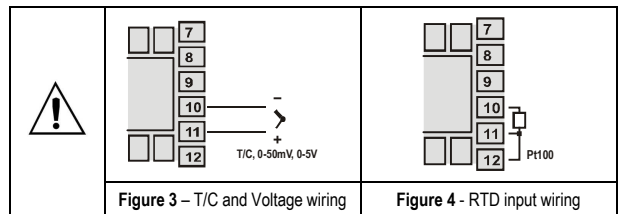
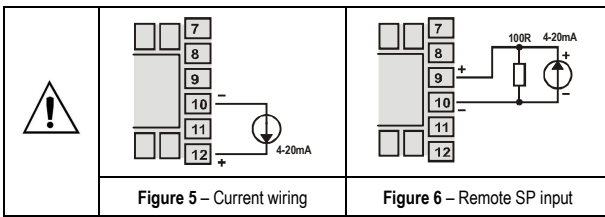

Figure 3 – T/C and Voltage wiring

Figure 4 - RTD input wiring

• **RTD (Pt100)**

Figure 4 shows the Pt100 wiring, for 3 conductors. Terminals 10, 11 and 12 must have the same wire resistance for proper cable length compensation. For 2 wire Pt100, short circuit terminals 11 and 12.



• **4-20 mA**

Refer to **Figure 5**. (The controller provides an internal electronic shunt for the input current. No changes in the circuit are necessary).

• **Remote setpoint**

Input available at terminals 9 and 10. The user must connect a 100 Ω resistor shunt as indicated in **Figure 6**.

• **Digital Input**

I/O3 and I/O4 can be used as digital inputs, accepting either dry contact or NPN open collector signals. **Figure 7a** shows a switch driving the I/O3 digital input. I/O4 can be used analogously. The digital input at I/O5 is driven only by dry contact signals. **Figure 7b** shows a typical digital input wiring for I/O5.

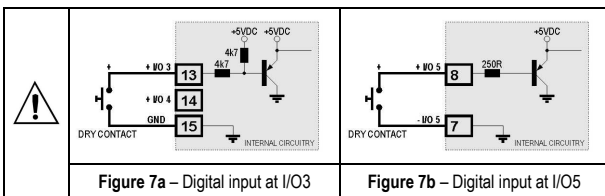

• **Digital Output**

I/O3, I/O4 and I/O5 can also be configured as digital outputs (I/O3 and I/O4 provide a 5 Vdc output signal whereas I/O5 a 12 Vdc signal). An example of usage is shown in **Figure 8** for the I/O3 and in **Figure 9** for the I/O5. I/O5 is electrically isolated from the sensor input.

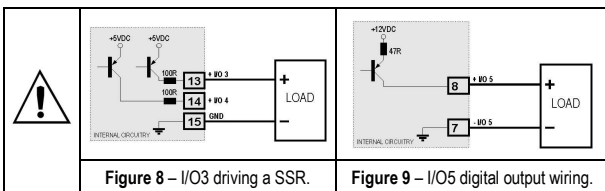

OPERATION

The front panel is shown in **Figure 10**.

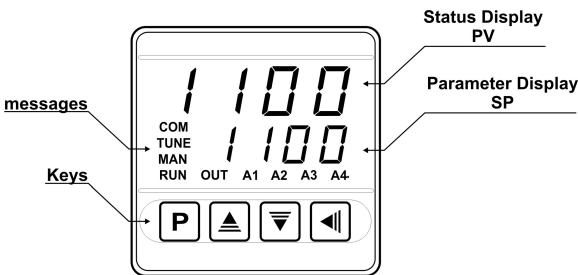

Figure 10 - Front panel parts

Status display/PV: shows the value of PV (Process Variable). When in programming mode, shows the parameter name.

Parameter display/SV: shows the SV (Setpoint Variable) value and the value of other parameters of the controller.

COM Indicator: Flashes when communication messages are sent by the controller.

TUNE Indicator: Lights during the execution of PID automatic tuning.

MAN Indicator: Lights when the controller is in manual.

RUN Indicator: Lights when the controller is active, with control and alarm outputs enabled.

OUT Indicator: For relay or pulse control output, reflects the actual state of the output. If an analog output is assigned for control, lights continuously.

A1, A2, A3 and A4 Indicators: Status of the alarms.

[P] - **PROG key:** used to walk through the menu cycles

[◀] - **BACK key:** go back to the previous displayed parameter

[▲] - **INCREASE** and **[▼]** - **DECREASE keys:** Used to change parameter values

When the controller is turned on, its firmware version is displayed for 3 seconds, after which the controller starts normal operation. The values of PV and SV are displayed and the outputs are enabled.

Before the controller is ready to be used in a given process, it requires some basic configuration, such as:

- input type (T/C, Pt100, 4-20 mA,...) at the **"TYPE"** prompt, according to **Table 1**.
- output type at "I/O 1", "I/O 2",... "I/O 5" prompts (see **Table 2**).
- setpoint variable SV. Set the remaining parameters.
- PID parameters (or hysteresis for ON / OFF control).

Other functions, including alarms, ramp and soak, timer, digital input, etc., may be useful for a better system performance. The parameters are grouped in 7 cycles.

CYCLE	ACCESS
1- Operation	Free access parameters *
2- Tuning	Reserved access parameters **
3- R&S Program	
4- Alarms	
5- Input Configuration	
6- I/Os	
7- Calibration	

* These parameters can be viewed but not changed if the cycle is protected.

** Requires a key combination to access the cycle.

Press **[P]** to advance and **[◀]** to go back in the menu cycle.

Keep pressing the **[P]** or **[◀]** key to move fast forward or backward.

Press **[◀]** and **[P]** simultaneously to move from one cycle to the next one.

At the end of each cycle the controller returns to the operation cycle.

PROGRAM SECURITY

Each menu cycle can be locked (protected) by pressing **[◀]** and **[▲]** simultaneously for 3 seconds. Press **[◀]** and **[▼]** for 3 seconds to unlock. A short blink of the display confirms the lock/unlock change. This will alternately lock or unlock the **[▲]** and **[▼]** keys to avoid tampering.

For further protection, the unlock operation through the keypad may be disabled by changing the position of an internal strap inside the controller:

When PROT is OFF, the user is allowed to lock and unlock the cycles using the keypad as explained above. If PROT is ON, the cycles lock / unlock operation is disable.

CONFIGURATION

INPUT TYPE SELECTION

Select the input type (in parameter "TYPE" from **Table 1** below.

TYPE	CODE	CHARACTERISTICS
J	0	Range: -50 to 760 °C (-58 to 1400 °F)
K	1	Range: -90 to 1370 °C (-130 to 2498 °F)
T	2	Range: -100 to 400 °C (-148 to 752 °F)
N	3	Range: -90 a 1300 °C (-130 a 2372 °F)
R	4	Range: 0 a 1760 °C (32 a 3200 °F)
S	5	Range: 0 to 1760 °C (32 to 3200 °F)
Pt100	6	Range: -199.9 to 530.0 °C (-328.0 to 986.0 °F)
Pt100	7	Range: -200 to 530 °C (-328 to 986 °F)
4-20 mA	8	J linearization. Programmable range: -110 to 760 °C
4-20 mA	9	K linearization. Programmable range: -150 to 1370 °C
4-20 mA	10	T linearization. Programmable range: -160 to 400 °C
4-20 mA	11	N Linearization. Programmable range: -90 a 1370 °C
4-20 mA	12	R Linearization. Programmable range: 0 a 1760 °C
4-20 mA	13	S linearization. Programmable range: 0 to 1760 °C
4-20 mA	14	Pt100 linearization. Prog. Range:-200.0 to 530.0 °C
4-20 mA	15	Pt100 linearization Prog. Range:-200 to 530 °C
0-50 mV	16	Linear. Programmable indication -1999 to 9999
4-20 mA	17	Linear. Programmable indication -1999 to 9999
0-5 Vdc	18	Linear. Programmable indication -1999 to 9999
4-20 mA	19	Square Root Extraction

Table 1 - Input Types

OUTPUTS, ALARMS AND DIGITAL INPUTS CONFIGURATION

The controller input/output channels can assume multiple functions, depending on configuration: control output, alarm output, digital output, digital input, and PV or SV analog retransmission. These channels are identified as I/O1, I/O2, I/O3, I/O4 and I/O 5.

The basic controller model comes loaded with:

- I/O1 - relay output
- I/O2 - relay output
- I/O5 - analog output (0-20 or 4-20mA), pulse 10V max, digital I/O

The options available are:

- I/O3 - 3rd relay (option 1)
- I/O3 and I/O4 - 2 digital input/output (option 2)
- Heater break protection (option 3).

The function code of each I/O can be selected among the options on **Table 2**. Only valid function codes are displayed for each I/O (for example, I/O1, which is a relay, can be configured with functions 0 to 5 only; on the other hand, I/O5 can perform all 16 functions).

The description for the functions follows:

- CODE 0 - No function. The I/O channel programmed with code 0 will not be used by the controller. It is available to be used by serial communication as digital output.
- CODES 1 to 4 - Alarm output - Available for all I/O channels. The selected channel can be used as output to Alarms 1 to 4.
- CODE 5 - PWM control output - Available for all I/O channels.
- CODE 6 - Digital input - Standard for I/O5 and optional for I/O3 and I/O4.
Closed : Manual control
Opened: Automatic control

- CODE 7 - Digital input - Standard for I/O5 and optional for I/O3 and I/O4. Start/Stop input ("run" : YES / no).
Closed : outputs enabled
Opened: outputs disabled
- CODE 8 - Digital input - Standard for I/O5 and optional for I/O3 and I/O4.
Closed: remote SP (4-20 mA in remote SP input)
Opened: main SP (internal programmed SV)

CODE	I/O TYPE	I/O FUNCTION
0	Digital Output	Digital Output to be set by the serial comm.
1	Digital Output	Alarm 1 Output
2	Digital Output	Alarm 2 Output
3	Digital Output	Alarm 3 Output
4	Digital Output	Alarm 4 Output
5	Digital Output	PWM Control Output
6	Digital Input	Automatic/Manual mode change
7	Digital Input	Run/Stop mode change
8	Digital Input	Select Remote Set Point Input
9	Digital Input	Executes/Holds selected ramp and soak profile
10	Digital Input	Enable/Disable R&S profile 1 selection
11	Analog Output	0 to 20mA Analog control output
12	Analog Output	4 to 20mA Analog control output
13	Analog Output	0 to 20mA PV retransmission
14	Analog Output	4 to 20mA PV retransmission
15	Analog Output	0 to 20mA SP retransmission
16	Analog Output	4 to 20mA SP retransmission

Table 2 - I/O channel functions

- CODE 9 - Digital input - Standard for I/O5 and optional for I/O3 and I/O4.
Opened: enables R&S program
Closed: holds R&S program (the program resumes when the contact is opened again)
- CODE 10 - Digital input - Standard for I/O5 and optional for I/O3 and I/O4. Selects R&S program 1. Used to alternate between the main Setpoint and a second Setpoint defined by the R&S program 1.
Closed : selects program 1
Opened: uses main Setpoint
- CODE 11 - Analog control output - I/O5 only. 0-20 mA control output.
- CODE 12 - Analog control output - I/O5 only. 4-20 mA control output.
- CODES 13 to 16 - Analog retransmission. I/O5 only. Configures I/O5 to output a 0-20 mA or 4-20 mA analog signal proportional to PV or SP.

ALARM FUNCTIONS

The controller has 4 independent alarms. They can be programmed to operate with nine different functions, represented in **Table 3**.

- Open sensor
It is activated whenever the input sensor is broken or disconnected.
- Event alarm
It activates alarm(s) in specific segments of the program.
- Resistance fail
Detects a heater broken condition, by monitoring the load current when the control output is activated. This alarm function requires an optional device (option 3). Details of the "resistance fail" option can be found in a specific documentation that is sent with the product when the option is purchased.

TYPE	PROMPT	ACTION
Disabled	OFF	No active alarm. This output can be used as a digital output to be set by the serial communication.
Sensor Break (input Error)	IErr	Alarm will be ON if PV sensor breaks, input signal is out of range or Pt100 is shorted.
Event Alarm (ramp and Soak)	rS	Can be activated at a specific segment of ramp and soak program.
Detection resistance fail	rFRIL	Detects a heater broken condition
Low Alarm	Lo	
High Alarm	Hi	
LOW Differential	dIFL	
HIGH Differential	dIFH	
Differential	dIF	

Table 3 - Alarm functions

Where SPAn means “**SPR1**”, “**SPR2**”, “**SPR3**” and “**SPR4**”.

- Minimum value
It is activated when the measured value is below the value defined in the alarm Setpoint.

- Maximum value
It is activated when the measured value is above the value defined in the alarm Setpoint.

- Differential (or Band)
In this function, the parameters “**SPR1**”, “**SPR2**” represent the PV deviation as compared to the main SP.

In a positive deviation, the differential alarm will be triggered when the measured value is **out** of the range defined in:

$$(SP - Deviation) \text{ and } (SP + Deviation)$$

In a negative deviation, the differential alarm will be triggered when the measured value is **within** the range defined above.

- Minimum differential
It is activated when the measured value is below the value defined in.

$$(SP - Deviation)$$

- Maximum differential
It is activated when the measured value is above the value defined in:

$$(SP + Deviation)$$

ALARM TIMER FUNCTIONS

Alarms 1 and 2 can be programmed to have timer functions. The 3 modes of operation are:

- pulse
- delayed actuation
- oscillator

The desired function can be achieved programming the parameters “**R1t1**”, “**R1t2**”, “**R2t1**” and “**R2t2**” (see Table 4).

The LEDs associated to the alarms will light when the alarm condition is recognized, not following the actual state of the output, which may be temporarily OFF because of the temporization.

ALARM INITIAL BLOCKING

The initial blocking option inhibits the alarm from being recognized if an alarm condition is present when the controller is first energized. The alarm will actuate only after the occurrence of a non alarm condition followed by a new occurrence for the alarm.

The initial blocking is disabled for the sensor break alarm function.

ALARM FUNCTION	T1	T2	ACTION
Normal	0	0	
Delayed	0	1 s to 6500 s	
Pulse	1 s to 6500 s	0	
Oscillator	1 s to 6500 s	1 s to 6500 s	

Table 4 - Advanced Timer Alarm (for alarms 1 or 2)

SOFT START

Defines the time interval for the output to reach its maximum value (100 %). The soft start value is programmed in “**SFSt**”. See also parameters “**ouLL**” and “**ouHL**”.

SQUARE ROOT EXTRACTION

Available when input type 19 is selected. The indicator displays the square root of the current signal input applied to terminals 10 and 11.

REMOTE SETPOINT

The remote Setpoint (SP) is enabled by an external digital signal in either I/O3, I/O4 or I/O5, when programmed with the code 8 (Select remote SP input).

An external resistor shunt of 100 Ω is required between the terminals 9 and 10, as shown in Figure 6.

ANALOG RETRANSMISSION OF PV AND SP

The analog output, when not used for control purposes, is available for retransmitting the SV and SP values in 0-20 or 4-20 mA. This analog output is electrically isolated from other inputs and outputs.

The analog output signal is scaleable, with the output range determined by the values programmed in the parameters “**SPLL**” and “**SPHL**”.

To obtain a voltage output, connect a resistor shunt to the current output terminals (terminal 7 and 8).

CONFIGURATION PARAMETERS

OPERATION CYCLE

PV Indication (Red)	PV AND SV INDICATION: The status display shows the present value of PV (Process Variable). The parameter display shows SV (Set Variable).
SV Indication (Green)	
	The status display shows "----" whenever PV exceeds the maximum range or there is no signal at the input. In case of hardware error the status display will show Errn , where n is the error code.
Auto	CONTROL MODE: YES indicates automatic control mode (closed loop, PID or ON/OFF). NO indicates manual control mode (open loop). Bumpless transfer from auto ↔ to manual mode is available. If in doubt program YES .
PV Indication (Red)	MANIPULATED VARIABLE VALUE (MV): The upper display shows PV value and the lower display shows the percentage of MV applied to the control output. When in manual control the MV value can be manually changed. When in auto mode the MV value can only be viewed.
MV Indication (Green)	
	To distinguish the MV display from the SV display, the MV is shown flashing intermittently.
Pr n	RAMP AND SOAK PROGRAM SELECTION: Selects the ramp and soak program to be executed (7 programs possible). Refer to chapter 7 for R&S description.
run	CONTROL ENABLE: YES means that the control output and alarms are enabled and NO means they are disabled.

AUTO TUNING CYCLE

Autun	AUTO-TUNE: YES enables the auto tuning of the PID parameters and NO disables it.
Pb	PROPORTIONAL BAND: Percentage of maximum input span. Select zero for ON/OFF control.
HYSt	CONTROL HYSTERESIS (in engineering units): This parameter is only shown for ON / OFF control (Pb=0).
Ir	INTEGRAL RATE: Integral time constant in repetitions per minute (Reset).
dT	DERIVATIVE TIME: Derivative time constant, in seconds.
CT	CYCLE TIME: PWM period in seconds. Can only be viewed if proportional band is other than zero.
Act	CONTROL ACTION: For Auto Mode only. <ul style="list-style-type: none"> • rE Reverse Action usually used for heating. • dIr Direct Action usually used for cooling.
bIAS	Offset for MV (manual reset). Range: -100 % to +100 %. Default value: 0.
ouLL	OUTPUT LOW LIMIT: minimum percentage value for MV (Manipulated Variable) when in automatic control and PID. Default value: 0.0 %
ouHL	OUTPUT HIGH LIMIT: Maximum percentage value for MV when in automatic control and PID. Default value: 100.0%
SFSt	SOFT START: Time in seconds during which the controller limits the MV value progressively from 0 to 100 %. It is enabled at power up or when the control output is activated. If in doubt set zero.
SPA1 SPA2 SPA3 SPA4	ALARM PRESET: Tripping point for alarm 1, 2, 3 and 4.

RAMP AND SOAK PROFILE PROGRAMMING CYCLE

tBAS	TIME BASE: Selects the time base for the ramp and soak. Valid for all profile programs. <ul style="list-style-type: none"> • 0 - PT1 to PT7 values are in seconds; • 1 - PT1 to PT7 values are in minutes;
Pr n	PROGRAM TO BE VIEWED: Selects the ramp and soak profile program to be edited/viewed in the following cycle prompts (7 programs available).
Ptol	RAMP AND SOAK TOLERANCE: maximum deviation between PV and SV. Whenever this deviation is exceeded the time counter is halted until deviation lowers to within the tolerance. Set zero to disable this function.
PSP0 PSP7	RAMP AND SOAK SET POINTS (0 to 7): Set of 8 SV values which define the ramp and soak profile segments. See also PT1 to 7 and PE1 to 7 below.
PT1 PT7	RAMP AND SOAK SEGMENTS TIME (1 to 7): Set of 7 time intervals in minutes or seconds (9999 max.) for the 7 segments of the ramp and soak program.
PE1 PE7	RAMP AND SOAK EVENT (1 to 7): Set of 7 values that define which alarms must be activated during a ramp and soak program segment. Alarm function depends on " rS " setting (Table 3).
LP	LINK TO PROGRAM: Number of the next profile program to be linked to follow the current profile. Profiles can be linked to make larger programs of up to 49 segments.

ALARM CYCLE

FuA1	ALARM 1 FUNCTION: Select options from Table 3.
FuA2	ALARM 2 FUNCTION: Select options from Table 3.
FuA3	ALARM 3 FUNCTION: Select options from Table 3.
FuA4	ALARM 4 FUNCTION: Select options from Table 3.
bLA1 bLA2 bLA3 bLA4	ALARM BLOCK 1 TO 4: This function blocks the alarm at power-up when the units is first energized. YES enables and NO inhibits this blocking function. When enabled the alarm will not be active at power-up waiting for PV (Process Variable) to reach a non-alarm situation. From this point on the alarm will be free to actuate should a new alarm situation occur.
HYA1 HYA2 HYA3 HYA4	ALARM HYSTERESIS: Defines the differential range between the PV value at which the alarm is turned on and the value at which it is turned off (in engineering units).
A1t1	ALARM 1 TIME 1: Defines the time (6500 sec. max.) during which the alarm 1 output will be ON when alarm 1 is active. Program zero to disable this function.
A1t2	ALARM 1 TIME 2: Defines the OFF state time for the alarm 1 output, after being ON during the time selected on ALARM 1 TIME 1. Program zero to disable this function.
A2t1	ALARM 2 TIME 1: Defines the time (6500 sec. max.) during which the alarm 1 output will be ON when alarm 1 is active. Program zero to disable this function.
A2t2	ALARM 2 TIME 2: Defines the time during which the alarm 2 output will be, after being ON during the time selected on ALARM 2 TIME 1. Program zero to disable this function. Table 4 shows the advanced features that can be achieved with these time functions.



CONFIGURATION CYCLE



TYPE	INPUT TYPE: Selects the input signal type to be connected to the process variable input. Refer to Table 1 . <i>This is the first parameter to be set.</i>
dPPO	DECIMAL POINT POSITION: For input types 16, 17, 18 or 19 only. Selects the decimal point position to be viewed in both PV and SV.
unit	TEMPERATURE INDICATION IN °C OR °F: Selects the display indication to be in °C or °F. Only available if input type is other than 16, 17, 18 or 19.
OFFS	SENSOR OFFSET: Offset value to be added to the PV to compensate sensor error. Default value: zero.
SPLL	SET POINT LOW LIMIT: - Linear inputs: Sets the lower range for SV and PV indication. - T/C and Pt100 inputs: sets the lower range for SV.
SPHL	SET POINT HIGH LIMIT: - Linear inputs: Sets the upper range for SV and PV indication. - T/C and Pt100 inputs: sets the upper range for SV.
rSLL	REMOTE SET POINT LOW LIMIT: Selects the lower range for indication of the Remote Setpoint.
rSHL	REMOTE SET POINT HIGH LIMIT: Selects the upper range for indication of the Remote Setpoint.
bRud	DIGITAL COMMUNICATON BAUD RATE SELECTION: 0: 1200 bps; 1: 2400 bps; 2: 4800 bps; 3: 9600 bps; 4: 19200 bps.
Raddr	SLAVE ADDRESS SELECTION: Identifies a slave in the network. The possible address numbers are from 1 to 247.



I/O CYCLE (INPUTS AND OUTPUTS)

Io 1	I/O 1 FUNCTION: Selects the I/O function to be used at I/O 1 (relay 1). Options 0 to 5 are possible for this output. It is normally used as option 5, PWM main control output. Refer to Table 2 for functions.
Io 2	I/O 2 FUNCTION: Selects the I/O function to be used at I/O 2 (relay 2). Options 0 to 5 are available. This output is normally used as alarm output. See Table 2 for functions.
Io 3	I/O 3 FUNCTION: Selects the I/O function to be used at I/O 3 (option 1). I/O 3 can be a relay output or a digital input/output. Functions 0 to 10 are available. Refer to Table 2 for functions. The presence of this I/O option is detected by the controller and the prompt menu will only be shown if the expansion option is available.
Io 4	I/O 4 FUNCTION: Selects the I/O function to be used at I/O 4 (option 2). I/O 4 can be a digital input/output. Functions 0 to 10 are available. Refer to Table 2 for functions. The prompt menu will only be shown if the expansion option is present.
Io 5	I/O 5 FUNCTION: Selects the I/O function to be used at I/O 5 (Analog Output). Functions 0 to 15 are available (See Table 2). This option is normally used for main control output or PV analog retransmission.

CALIBRATION CYCLE

All input and output types are factory calibrated. This cycle should only be accessed by experienced personnel. If in doubt do not press the  or  keys in this cycle.

InLL	INPUT LOW CALIBRATION: Sets the Process Variable low calibration (offset). Several keystrokes at  or  might be necessary to increment one digit.
InHL	INPUT HIGH CALIBRATION: Sets the Process Variable span calibration (gain).

ouLL	OUTPUT LOW CALIBRATION: Sets the analog current output low calibration (offset).
ouHL	OUTPUT HIGH CALIBRATION: Sets the analog current output span calibration (gain).
CJL	COLD JUNCTION OFFSET CALIBRATION: Sets the cold junction offset calibration.
HtYP	HARDWARE TYPE: Configures the controller to recognize the actual installed optional hardware (accessories). The parameters menu will show the parameters relative to the optional hardware: 0 - no optionals or c/ RS485 only; 1 - relay 3 (I/O 3); 2 - Digital I/O (2 inputs/outputs: I/O3 and I/O4); 3 - Heater break protection (option);
rSLC	REMOTE SET POINT LOW CALIBRATION: Sets the Remote Set Point low calibration (offset). Several keystrokes at  or  might be necessary to increment one digit.
rSHC	REMOTE SET POINT HIGH CALIBRATION: Sets the Remote Set Point span calibration (gain).

RAMP AND SOAK PROFILE PROGRAM

Seven ramp and soak profiles with up to 7 segments each can be programmed. Longer profiles of up to 49 segments can be created by linking 2 or more profiles.

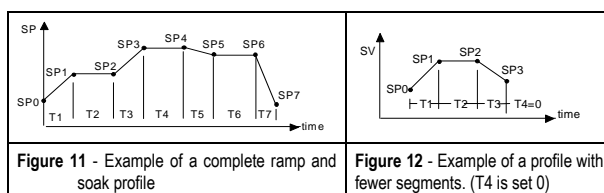

To execute a profile with fewer segments just program 0 (zero) for the time intervals that follow the last segment to be executed.

The program tolerance "**Ptol**" defines the maximum deviation between PV and SV for the execution of the profile. If this deviation is exceeded, the program will be interrupted until the deviation falls to within the tolerance band.

Programming 0 (zero) at this prompt disables the tolerance and the profile execution will not to be halted even if PV does not follow SV (time priority as opposed to SV priority).

LINK OF PROGRAMS

It is possible to create a more complex program, with up to 49 segments, joining the seven programs. This way, at the end of a program execution the controller immediately starts to run another one.

When a program is created, it must be defined in the "**LP**" screen whether there will be or not another program.

To make the controller run a given program or many programs continuously, it is only necessary to link a program to itself or the last program to the first.

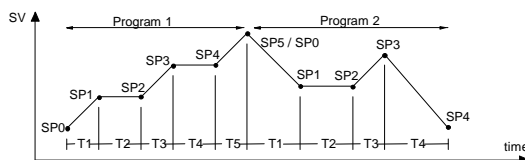

Figure 13 - Example of two linked programs

EVENT ALARM

This function makes possible to program the activation of alarms in specific segments of a program.

For such, alarms must have their function set as "r5" and be programmed in "PE1" to "PE7" according to Table 6. The number programmed in the event prompt defines the alarms to be activated.

To configure and execute a ramp and soak program:

- Program the tolerance value, SV, time and event.
- If any event alarm is required program the ramp and soak event function.
- Set the control mode to automatic.
- Select ramp and soak program to be executed at prompt **Prn** (0 to 7)
- Start control at the **run** prompt by selecting YES.

Before executing the program the controller waits for PV to reach the first set point SP0 if **PEOL** is different than zero.

Should any power failure occur the controller resumes at the beginning of the segment it currently is.

CODE	ALARM 1	ALARM 2	ALARM 3	ALARM 4
0				
1	X			
2		X		
3	X	X		
4			X	
5	X		X	
6		X	X	
7	X	X	X	
8				X
9	X			X
10		X		X
11	X	X		X
12			X	X
13	X		X	X
14		X	X	X
15	X	X	X	X

Table 5 - Event codes for ramp and soak

AUTO TUNE

During auto tune the process is controlled in ON / OFF mode at the programmed SetPoint (SV). Depending on the process characteristics large oscillations above and below SV may occur and auto tuning may take several minutes to be concluded.

The recommended procedure is as follows:

- Disable the control output at the **run** prompt by selecting NO.
- Select auto mode operation at the **Auto** prompt by selecting YES.
- Disable the ramp and soak function (select NO) and program a new SV value other than the present PV (close to the desired set point).
- Enable auto tuning at the **AutoTune** prompt by selecting YES.
- Enable the control output at the **run** prompt by selecting YES.

During the auto tune procedure the soft-start function will not operate and large oscillations will be induced around the setpoint. Make sure the process can accept these oscillations and fast control output changes.

If auto tuning results are not satisfactory refer to Table 6 for manual fine tuning procedure.

PARAMETER	RESPONSE	SOLUTION
Proportional Band	Slow Response	Decrease
	Large Oscillation	Increase
Integral Rate	Slow Response	Increase
	Large Oscillation	Decrease
Derivative Time	Slow Response or Instability	Decrease
	Large Oscillation	Increase

Table 6 - Suggestions for manual tuning of PID parameters

PROBLEMS WITH THE CONTROLLER

Connection errors and inadequate programming are the most common errors found during the controller operation. A final review may avoid loss of time and damages.

The controller displays some messages to help the user identify problems.

MESSAGE	PROBLEM
----	Open input. Without sensor or signal.
Err1 Err6	Configuration or connection problem in the Pt100 cable





Other error messages displayed by the controller can account for errors in the input connections or type of selected input non compliant with the sensor or signal applied to the input. If errors persist, even after a review, contact the manufacturer. Inform also the device serial number. To find out the serial number, press  for more than 3 seconds.

The controller also has a visual alarm (the display flashes) when the PV value is out of the range set by **SPHL** and **SPLL**.





CALIBRATION

INPUT CALIBRATION

All inputs are factory calibrated and recalibration should only be done by qualified personnel. If you are not familiar with these procedures do not attempt to calibrate this instrument. The calibration steps are:

- Select the input type to be calibrated.
- Set the desired upper and lower display limits.
- At the input terminals inject an electrical signal corresponding to a known indication value a little higher than the lower display limit.
- Select the **InLC** prompt. Through the  and  keys adjust PV so that it matches the injected signal.
- Inject a signal that corresponds to a value a little lower than the upper limit of the display.
- Select the **InHC** prompt. Through the  and  keys adjust PV so that it matches the injected signal.
- Repeat steps c) to f) to improve calibration.

ANALOG OUTPUT CALIBRATION

- Select type 11 or 12 at the I/O5 prompt.
- Connect a current meter at the analog output.
- Disable the auto-tune and soft-start functions.
- Set the output low limit **ouLL** to 0.0 % and the output high limit **ouHL** to 100.0 %.
- Select the manual mode at the **Auto** prompt.
- Enable the output at the **run** prompt.
- At the operation cycle, set the MV to 0.0 %.
- At the output low calibration **ouLC** prompt, press the  and  key until the mA meter reads zero mA. Approach this value from above.
- Set 100.0 % for the manipulated variable (MV).
- At the output high calibration **ouHC** prompt, press the  and  key until the mA meter reads 20 mA. Approach this value from below.
- Repeat steps 7) to 10) as necessary.

SERIAL COMMUNICATION

The indicator can be supplied with an asynchronous RS-485 digital communication interface for master-slave connection to a host computer (master).

The indicator works as a slave only and all commands are started by the computer which sends a request to the slave address. The addressed unit sends back the requested reply.

Broadcast commands (addressed to all indicator units in a multidrop network) are accepted but no reply is sent back in this case.

CHARACTERISTICS

RS-485 compatibility with two-wire connection from the host to up to 31 slaves in a multidrop network topology. Up to 247 units can be addressed by the MODBUS RTU protocol. Maximum network distance: 4,000 feet. Time of indicator disconnection: Maximum of 2 ms after the last byte.

Te communication signals are electrically isolated from the rest of the instrument, and can be 1200, 2400, 4800, 9600, 19200, 38400, and 57600 bps.

- Number of data bits: 8, without parity or pair parity
- Number of stop bits: 1
- Time to start response transmission: up to 100 ms after acknowledging the command.
- Protocol: MODBUS (RTU)

RS485 INTERFACE: ELECTRICAL CONNECTION

The RS-485 signals are:

D1 = D: Bidirectional data line

D0 = \bar{D} : Inverted bidirectional data line

C = GND: Ground. Optional connection to improve communication performance

SPECIFICATIONS

DIMENSIONS: 48 x 48 x 110 mm (1/16 DIN).
Approximate weight: 150 g

PANEL CUT-OUT: 45,5 x 45,5 mm (+0.5 -0.0 mm)

TERMINAL CONNECTION: 18 screws accepting 6.3 mm fork lugs

POWER: 100 to 240 Vac/dc ($\pm 10\%$), 50/60 Hz. Transient overvoltage: ± 2 kV
Optional: 24 Vac/dc $\pm 10\%$
Max. Consumption: 9 VA

ENVIRONMENTAL CONDITIONS: 5 to 50 °C
Relative humidity (maximum): 80 % up to 30 °C. For temperatures above 30 °C, decrease 3 % per °C. Installation category II. Pollution degree 2. Altitude < 2000 m.

INPUT Keyboard selection of input type (refer to **Table 1**)

Internal resolution: 19500 levels

Display resolution: 12000 levels (from -1999 to 9999)

Input sample rate: 5 per second

Accuracy: Thermocouples J, K and T: 0.25 % of span ± 1 °C

..... Thermocouple N, R, S: 0.25 % of span ± 3 °C

..... Pt100: 0.2 % of span

..... 4-20 mA, 0-50 mV, 0-5 Vdc: 0.2 % of span

Input impedance: 0-50 mV, Pt100 and thermocouples: >10 M Ω

..... 0-5 V: >1 M Ω

..... 4-20 mA: 15 Ω (+2 Vdc @ 20 mA)

Pt100 measurement: standard ($\alpha=0.00385$).

Excitation current: 0.170 mA. 3-wire circuit, cable resistance compensation.

All input types are factory calibrated according to IEC-584 for thermocouples and IEC-751 for Pt100.

ANALOG OUTPUT (I/O5): 0-20 mA or 4-20 mA, 550 Ω max.

..... 1500 levels, Isolated

..... control output or PV or SP retransmission

CONTROL OUTPUT: Relays SPST-NO (I/O1 AND I/O2):

1.5 A / 240 Vac.

..... Relays SPDT (I/O3): 3 A / 250 Vac

..... Logic pulse for SSR drive (I/O5): 10 V max / 20 mA

..... Logic pulse for SSR drive (I/O3 AND I/O4): 5 V max / 20 mA

SECOND ANALOG INPUT: 4-20 mA remote set point (standard).

This feature requires an external shunt resistor, provided with the instrument, to be connected to terminals 9 and 10.

EMC: EN 61326-1:1997 and EN 61326-1/A1:1998

SAFETY: EN61010-1:1993 and EN61010-1/A2:1995

PROGRAMMABLE PWM CYCLE FROM 0.5 SEC. AND 100 SEC.;

START UP 3 SECONDS AFTER POWER UP.

ORDERING INFORMATION

N1100 -	3R -	485 -	24V
A	B	C	D

- A:** Series model: **N1100;**
- B:** Optionals: **blank** (standard controller);
3R (3 relays);
HBD (Heater Break Detection);
DIO (digital I/O);
- C:** Digital communication: **blank;**
485 (RS485, Modbus protocol);
- D:** Voltage rating: **blank** (100 to 240 Vac);
24V (24Vac/dc).

WARRANTY

This product is covered by a 12-month warranty provided the purchaser presents the sales receipt and the following conditions are met:

- Products are covered for one year from the original date of purchase. Please retain the dated sales receipt as evidence of the date of purchase. You will need it for any warranty service
- Within this period, warranty against defects in material and workmanship under normal use is free of charge.
- For repair, send the product and the sales receipt to our address. Expenses and transportation risks are under the purchaser's responsibility.
- This warranty does not cover any damage due to accident, misuse, abuse, or negligence.