





# Controller N1100

## UNIVERSAL CONTROLLER – INSTRUCTIONS MANUAL – V4.0x

### SAFETY ALERTS

The symbols below are used on the equipment and throughout this document to draw the user's attention to important operational and safety information.

	
<p><b>CAUTION:</b> Read complete instructions prior to installation and operation of the unit.</p>	<p><b>CAUTION OR WARNING:</b> Electrical shock hazard.</p>

All safety related instructions that appear in the manual must be observed to ensure personal safety and to prevent damage to either the instrument or the system. If the instrument is used in a manner not specified by the manufacturer, the protection provided by the equipment may be impaired.

### PRESENTATION

The N1100 is an extraordinarily versatile process controller. It holds in one single instrument all the main features needed for the vast majority of industrial processes. It accepts in a single model virtually all the sensors and signals used in the industry and provides the main output types required for the operation of diverse processes.

The configuration can be performed directly on the controller or through the USB interface. The *NConfig* software (free) is the configuration management tool. Connected to the USB of a *Windows* computer, the controller is recognized as a serial communications port (COM) running with a Modbus RTU protocol.

Through the USB interface, even if disconnected from the power supply, the configuration performed in a piece of equipment can be saved in a file and repeated in other pieces of equipment that require the same configuration.

It is important that the users read carefully this manual before using the controller. Verify if the release of this manual matches the instrument version (the firmware version is shown when the controller is energized).

### MAIN CHARACTERISTICS

- Multi-sensor universal input (sensors and standard signals);
- Protection for open sensor in any condition;
- Relay, 4-20 mA and logic pulse control outputs all available in the standard model;
- Self-tuning of PID parameters;
- Automatic / Manual function with "bumpless" transfer;
- Four modes of independent alarms, with functions of minimum, maximum, differential (deviation), open sensor and event;
- Timer functions that can be associated to the alarms;
- Retransmission of PV or SP in 0-20 mA or 4-20 mA;
- Input for remote setpoint;
- Digital input with 5 functions;
- Programmable *soft-start*;
- 7 setpoint profile programs with 7 segments each, with the ability to be linked together for a total of 49 segments;
- Password for parameters protection;
- Universal power supply.

### CONFIGURATION / FEATURES

Select the input type (in parameter "**TYPE**") from Table 1 below

TYPE	CODE	CHARACTERISTICS / RANGE OF MEASUREMENT
J	<b>J</b>	Range: -110 to 950 °C (-166 to 1742 °F)
K	<b>K</b>	Range: -150 to 1370 °C (-238 to 2498 °F)
T	<b>T</b>	Range: -160 to 400 °C (-256 to 752 °F)
N	<b>N</b>	Range: -270 to 1300 °C (-454 to 2372 °F)
R	<b>R</b>	Range: -50 to 1760 °C (-58 to 3200 °F)
S	<b>S</b>	Range: -50 to 1760 °C (-58 to 3200 °F)
B	<b>B</b>	Range: 400 to 1800 °C (752 to 3272 °F)
E	<b>E</b>	Range: -90 to 730 °C (-130 to 1346 °F)
Pt100	<b>Pt</b>	Range: -200 to 850 °C (-328 to 1562 °F)
0-50 mV	<b>L050</b>	Linear Signals Programmable indication from -1999 to 9999
4-20 mA	<b>L420</b>	
0-5 Vdc	<b>L05</b>	
4-20 mA	<b>Sqr</b>	4-20 mA input with Square Root extraction. Programmable indication from -1999 to 9999
4-20 mA NON LINEAR	<b>Ln J</b>	Non Linear Analog Signals Indication range depends on the selected sensor
	<b>Ln K</b>	
	<b>Ln T</b>	
	<b>Ln N</b>	
	<b>Ln R</b>	
	<b>Ln S</b>	
	<b>Ln B</b>	
<b>Ln E</b>		
	<b>LnPt</b>	

Table 1 – Input types

**Note:** All input types are factory calibrated.

### OUTPUTS, ALARMS AND DIGITAL INPUTS CONFIGURATION

The controller input and output channels (I / O) can assume multiple functions: control output, digital input, digital output, alarm output, retransmission of PV and SP. These channels are identified as I / O 1, I / O 2, I / O 3, I / O 4 and I / O 5.

The basic controller model comes loaded with the following features:

- I / O 1- output to Relay SPST-NA;
- I / O 2- output to Relay SPST-NA;
- I / O 5- current output, digital output, digital input;

**Optionally**, other features can be added, as shown under the item "Identification" in this manual:

- **3R:** I / O 3 with output to SPDT relay;
- **DIO:** I / O 3 and I / O 4 as digital input and output channels;
- **485:** Serial Communication

The function code of each I/O can be selected among the options on Table 2.

I/O TYPE	I/O FUNCTION	CODE
-	No function	<b>oFF</b>
Output	Alarm 1 Output	<b>A1</b>
Output	Alarm 2 Output	<b>A2</b>
Output	Alarm 3 Output	<b>A3</b>
Output	Alarm 4 Output	<b>A4</b>
Output	Control Output (Relay or Digital Pulse)	<b>ctrL</b>
Digital Input	Automatic/Man mode change	<b>iAn</b>
Digital Input	Run/Stop mode change	<b>run</b>
Digital Input	Selected Remote SP	<b>rSP</b>
Digital Input	Freezes program execution	<b>HPrg</b>
Digital Input	Program 1 selection	<b>Pr 1</b>
Analog Output	0 to 20 mA analog control output	<b>C.020</b>
Analog Output	4 to 20 mA analog control output	<b>C.420</b>
Analog Output	0 to 20 mA PV retransmission	<b>P.020</b>
Analog Output	4 to 20 mA PV retransmission	<b>P.420</b>
Analog Output	0 to 20 mA SP retransmission	<b>S.020</b>
Analog Output	4 to 20 mA SP retransmission	<b>S.420</b>

Table 2 - I/O channel functions

During the configuration of channels, only the valid options for each channel will be shown on the display. The description for the functions follows:

- **oFF** - No function

The I/O channel programmed with code **oFF** will not be used by the controller.

**Note:** Although without function, this channel is available through the serial communication (command 5 MODBUS).

- **A1, A2, A3, A4** – Alarm output

The selected channel can be used as output to alarms. Available for all the I/O channels.

- **ctrL** - PWM control output

Defines the channel to be used as control output (relay or digital pulse). Available for all the channels. The digital pulse is available on (when available) and I/O5.

- **iAn**–Digital input with Manual/Auto function

Defines the channel as Digital Input with the function of switching the control mode between **Automatic** and **Manual**. Available for I/O3, I/O4 (when available) and I/O5.

Closed Contact =Manual control / NO

Opened Contact = Automatic control / YES

- **run** - Digital input with RUN function

Defines channel as Digital Input with the function of enabling / disabling the control and alarm outputs ("**run**": **YES / no**). Available for I/O3, I/O4 (when available) and I/O5.

Closed Contact = Outputs enables / NO

Opened Contact = Outputs disables / YES

- **rSP**– Digital input with remote SP function

Defines channel as Digital Input with the function of selecting the remote SP. Available for I/O3, I/O4 (when available) and I/O5.

Closed Contact=Remote SP

Opened Contact = Main SP

- **HPrg** – Digital input with Hold Program function

Defines channel as Digital Input with the function of commanding the execution of the selected setpoint profile **program**. Available for I/O3, I/O4 (when available) and I/O5.

Closed Contact = Enables execution of the program

Opened Contact = Interrupts execution of the program

**Note:** Even when the execution of the program is interrupted, the control output remains active and controlling the process at the point (Setpoint) of interruption. The program will resume its normal execution starting from this same point when the digital input is closed.

- **Pr 1** – Digital input with function to Execute Program 1

Defines the channel as Digital Input with the function of commanding the execution of the setpoint profile program 1. Available for I/O3, I/O4 (when available) and I/O5.

Useful function for switching between the main setpoint and a secondary one defined by the **program 1**.

**Closed** = selects program 1

**Opened** = uses main Setpoint

- **C.020** –0-20 mA Control Output

Available for I/O 5 only, defines the channel as a 0-20 mA control output.

- **C.420** - 4-20 mA Control Output

Available for I/O 5 only, defines the channel as a 4-20 mA control output.

- **P.020** – 0-20 mA PV retransmission

Available for I/O 5 only, configures the channel to retransmit the PV measurement in 0-20 mA.

- **P.420** - 4-20 mA PV retransmission

Available for I/O 5 only, configures the channel to retransmit the PV measurement in 4-20 mA.

- **S.020** 0-20 mA SP (Setpoint) retransmission

Available for I/O 5 only, configures the channel to retransmit the values of SP in 0-20 mA.

- **S.420** 4-20 mA SP (Setpoint) retransmission

Available for I/O 5 only, configures the channel to retransmit the values of SP in 0-20 mA.

#### ALARMS FUNCTIONS

The controller has 4 independent alarms. They can be programmed to operate with eight different functions, represented in Table 3.

- **oFF** – Alarms turned **oFF**.

- **IErr** – Sensor break alarm

It is activated whenever the input sensor is broken or disconnected.

- **rS** – Ramp & soak program event alarm

This alarm is activated by the Ramp & Soak program (refer to the PROGRAMS OF RAMP AND SOAK section on how to set the event alarm).

- **rFA 1**– Reserved

- **Lo** – Alarm of Absolute Minimum Value

It is activated when the measured value is **below** the value defined in the alarm Setpoint.

- **Hi** – Alarm of Absolute Maximum Value

It is activated when the measured value is **above** the value defined in the alarm Setpoint.

- **dIF** – Alarm of Differential Value

In this function, the parameters "**SPA1**", "**SPA2**", "**SPA3**" and "**SPA4**" represent the PV deviation as compared to the main SP.

Using the Alarm 1 as example: for Positive SPA1 values, the differential alarm will be triggered when the PV value is **out** of the range defined in:

$$(SP - SPA1) \text{ to } (SP + SPA1)$$

For a negative SPA1 value, the differential alarm will be triggered when the PV value is **within** the range defined above

- **dIFL** – Alarm of Minimum Differential Value

It is activated when the PV value is below the value defined in:

$$(SP - SPA1)$$

Using the Alarm 1 as example.

- **dIFH** – Alarm of Maximum Differential Value

It is activated when the PV value is above the value defined in:

$$(SP + SPA1)$$

Using the Alarm 1 as example.

PROMPT	TYPE	ACTION
<b>oFF</b>	Disabled	Output is not used as alarm.
<b>IErr</b>	Sensor Break (input Error)	Activated when the input signal of PV is interrupted, out of the range limits or Pt100 in short-circuit.
<b>rS</b>	Event (ramp and Soak)	Can be activated at a specific segment of program.
<b>rFR IL</b>	-	Reserved
<b>Lo</b>	Minimum value (Low)	
<b>Hi</b>	Maximum value (High)	
<b>dIFL</b>	Minimum Differential (differential Low)	
<b>dIFH</b>	Maximum Differential (differential High)	
<b>dIF</b>	Differential (differential)	

Table 3 – Alarm functions

Where SPAn refers to Setpoints of Alarm “**SPR1**”, “**SPR2**”, “**SPR3**” and “**SPR4**”.

**ALARM TIMER MODES**

The controller alarms can be configured to perform 4 timer modes:

- Continuous (normal mode).
- One pulse with defined duration;
- Delayed activation;
- Repetitive pulses;

The illustrations in Table 4 show the behavior of the alarm output for various combinations of times T1 and T2. The timer functions can be configured in parameters **A1t1**, **A1t2**, **A2t1** and **A2t2**.

OPERATION	T 1	T 2	ACTION
Normal operation	0	0	
Activation for a defined time	1 s to 6500 s	0	
Activation with delay	0	1 s to 6500 s	
Intermittent activation	1 s to 6500 s	1 s to 6500 s	

Table 4 - Temporization Functions for the Alarms

The LEDs associated to the alarms will light when the alarm condition is recognized, not following the actual state of the output, which may be temporarily OFF because of the temporization.

**ALARM INITIAL BLOCKING**

The **initial blocking** option inhibits the alarm from being recognized if an alarm condition is present when the controller is first energized. The alarm will be enabled only after the occurrence of a non-alarm condition followed by a new occurrence for the alarm.

The initial blocking is useful, for instance, when one of the alarms is configured as a minimum value alarm, causing the activation of the alarm soon upon the process start-up, an occurrence that may be undesirable.

The initial blocking is disabled for the sensor break alarm function.

**SQUARE ROOT EXTRACTION**

When the input type is configured as **SPrt** the controller assumes the input as a 4-20 mA while extracting the square root of the applied input signal.

**ANALOG RETRANSMISSION OF PV AND SP**

The analog output, when not used for control purposes, is available for retransmitting the PV and SP values in 0-20 or 4-20 mA. This analog output is electrically isolated from other inputs and outputs.

The analog output signal is scalable, with the output range defined by the values programmed in the parameters “**SPLL**” and “**SPHL**”.

It is possible to obtain a voltage output by installing a resistor shunt (550 Ω max.) to the current output terminals (terminals 7 and 8). The actual resistor value depends on the desired output voltage span.

**SOFT-START**

The soft-start feature avoids abrupt variations in the power delivered to the load regardless of the system power demand.

This is accomplished by defining a limiting ramp for the control output. The output is allowed to reach maximum value (100 %) only after the time programmed in the soft-start parameter has elapsed.

The Soft-start function is generally used in processes that require slow start-up, where the instantaneous application of 100 % of the available power to the load may cause damages to parts of the system.

In order to disable this function, the soft-start parameter must be configured with 0 (zero).

**REMOTE SETPOINT**

The controller can have its Setpoint value defined by an analog, remotely generated signal. This feature is enabled through the channels I/O3, I/O4 or I/O5 when configured as digital inputs and configured with the function **rSP** (Remote SP selection) or through the parameter **ErSP**. The remote Setpoint input accepts the signals 0-20 mA, 4-20 mA, 0-5 V and 0-10 V.

For the signals of 0-20 and 4-20 mA, a shunt resistor of 100 Ω is required between terminals, as shown in Figure 4c.

**CONTROL MODE**

The controller can operate in two different manners: Automatic mode or Manual mode.

The parameter “**Auto**” defines the control mode to be adopted.

In Automatic mode the controller defines the amount of power to be applied on the process.

In Manual mode the user himself defines this amount of power. The user can then adjust the MV percentage while displaying **PV/MV**.

**PID AUTOMATIC MODE**

For the Automatic mode, there are two different strategies of control: PID automatic control and ON/OFF automatic control.

PID control has its action based on a control algorithm that takes into account the deviation of PV with respect to SP, the rate of change of PV and the steady state error. These parameters are particular to a system and can be obtained automatically by the controller’s Auto Tune feature (**Autun** parameter).

On the other hand, the ON/OFF control (obtained when **Pb=0**) operates with 0 % or 100 % of power, when PV deviates from SP.

The determination of parameters **Pb**, **Ir** and **dE** is described in the item DETERMINATION OF PID PARAMETERS of this manual.

### USB INTERFACE

The USB interface is used for CONFIGURING or MONITORING the controller. The **NConfig** software must be used for the configuration. It makes it possible to create, view, save and open configurations from the equipment or files in your computer. The tool for saving and opening configurations in files makes it possible to transfer configurations between pieces of equipment and to make backup copies. For specific models, the **NConfig** software also makes it possible to update the firmware (internal software) of the controller through the USB.

For MONITORING purposes you can use any supervisory software (SCADA) or laboratory software that supports the MODBUS RTU communication on a serial communications port. When connected to the USB of a computer, the controller is recognized as a conventional serial port (COM x). Use the **NConfig** software or consult the DEVICE MANAGER in the Windows CONTROL PANEL to identify the COM port that was assigned to the controller. Consult the mapping of the MODBUS memory in the controller's communications manual and the documentation of your supervisory software to conduct the MONITORING process.

Follow the procedure below to use the USB communication of the equipment:

1. Download the **NConfig** software from our website and install it on your computer. The USB drivers necessary for operating the communication will be installed together with the software.
2. Connect the USB cable between the equipment and the computer. The controller does not have to be connected to a power supply. The USB will provide enough power to operate the communication (other equipment functions cannot operate).
3. Open the **NConfig** software, configure the communication and start recognition of the device.
4. Consult the **NConfig** help desk for detailed instructions about how to use it and solve problems.

	<p>The USB interface IS NOT SEPARATE from the signal input (PV) or the controller's digital inputs and outputs. It is intended for temporary use during CONFIGURATION and MONITORING periods. For the safety of people and equipment, it must only be used when the piece of equipment is completely disconnected from the input/output signals. Using the USB in any other type of connection is possible but requires a careful analysis by the person responsible for installing it. When MONITORING for long periods of time and with connected inputs and outputs, we recommend using the RS485 interface, which is available or optional in most of our products.</p>
---	---

### INSTALLATION / CONNECTIONS

The controller must be fastened on a panel, following the sequence of steps described below:

- Prepare a panel cut-out of 45.5 x 45.5 mm;
- Remove the mounting clamps from the controller;
- Insert the controller into the panel cut-out;
- Slide the mounting clamp from the rear to a firm grip at the panel.

### RECOMMENDATIONS FOR THE INSTALLATION

- To minimize the pick-up of electrical noise, the low voltage DC connections and the sensor input wiring should be routed away from high-current power conductors. If this is impractical, use shielded cables. In general, keep cable lengths to a minimum.
- All electronic instruments must be powered by a clean mains supply, proper for instrumentation.
- It is strongly recommended to apply RC'S FILTERS (noise suppressor) to contactor coils, solenoids, etc.
- In any application it is essential to consider what can happen when any part of the system fails. The controller features by themselves can not assure total protection.

### ELECTRICAL CONNECTIONS

The controller complete set of features is drawn in **Figure 1**:

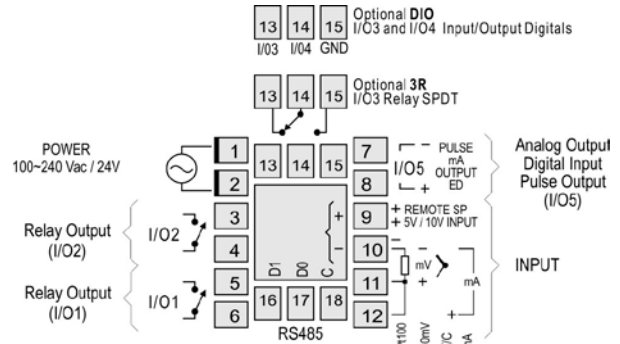

Figure 1 - Connections of the back panel

### Power Supply Connections

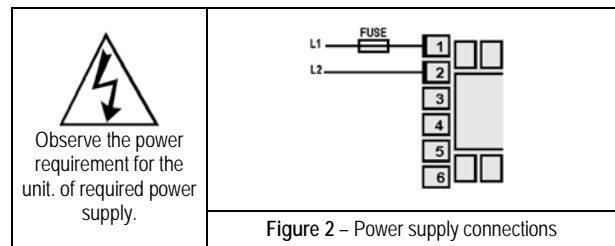

Figure 2 – Power supply connections

### Input Connections

- Thermocouple (T/C) and 0-50 mV

The **Figure 3a** indicates the wiring for the thermocouple and 0-50 mV signals. If the thermocouple wires need to be extended, use appropriate compensation cables.

- RTD (Pt100):

**Figure 3b** shows the Pt100 wiring, for 3 conductors. For proper cable length compensation, use conductors of same gauge and length). For 4-wires Pt100, leave one conductor disconnected at the controller. For 2-wire Pt100, short-circuit terminals 11 and 12.

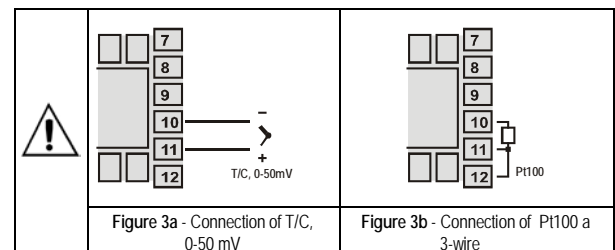

- 4-20 mA:

The connections for current signals 4-20 mA must be carried-out according to **Figure 4a**.

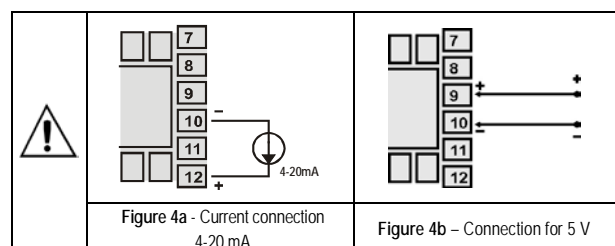

- 5 V

Refer to **Figure 4b** for connecting voltage signals.

**Remote Setpoint**

Feature available in the controller's terminals 9 and 10. When the Remote SP input signal is 0-20 mA or 4-20 mA, an external 100Ω shunt resistor must be connected to terminals 9 and 10 as indicated in Figure 4c.

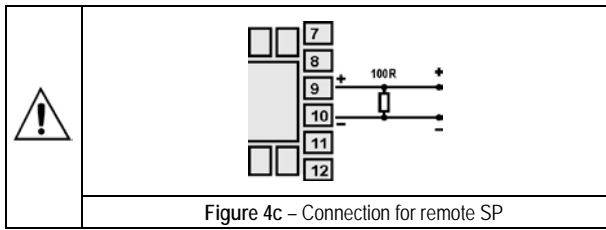

Figure 4c – Connection for remote SP

**Digital Input Connections**

Figures 5a and 5b show switches (Dry Contact) driving I/O3 (or I/O4) and I/O5.

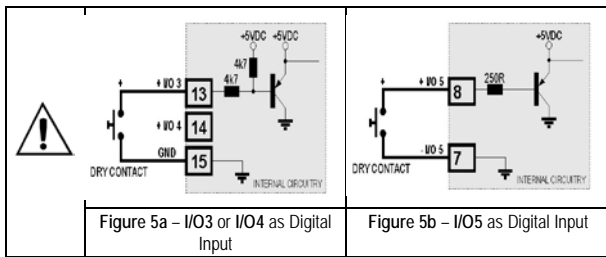

Figure 5a – I/O3 or I/O4 as Digital Input

Figure 5b – I/O5 as Digital Input

**Connection of Outputs**

The I/O channels, when configured as outputs, must have their load limit capacities observed, according to the product specifications.

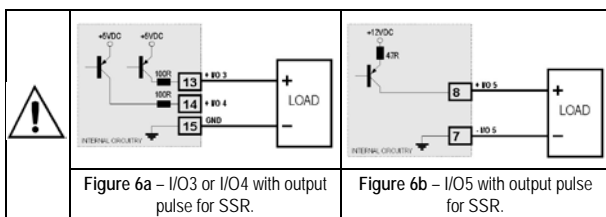

Figure 6a – I/O3 or I/O4 with output pulse for SSR.

Figure 6b – I/O5 with output pulse for SSR.

**OPERATION**

The controller's front panel, with its parts, can be seen in the Figure 7:



Figure 7 - Identification of the parts referring to the front panel

**Display of PV/Programming:** Displays the current value of PV (Process Variable). When in configuration mode, it shows the parameters names.

**Display of SP/Parameters:** Displays the value of SP (Setpoint). When in configuration mode, it shows the parameters values.

**COM indicator:** Flashes to indicate communication activity in the RS485 interface.

**TUNE indicator:** Stays on while the controller is in tuning process.

**MAN indicator:** Signals that the controller is in the manual control mode.

**RUN indicator:** Indicates that the controller is active, with the control output and alarms enabled.

**OUT indicator:** For relay or pulse control output; it reflects the actual state of the output. If an analog output is assigned for control (0-20 mA or 4-20 mA), the OUT indicator lights continuously.

**A1, A2, A3 and A4 indicators:** signalize the occurrence of alarm situation.

**P Key** used to walk through the menu parameters.

**Back Key:** used to retrocede parameters.

**Increment key and Decrement key:** allow altering the values of the parameters.

When the controller is powered on, its firmware version is presented for 3 seconds, after which the controller starts normal operation. The values of PV and SP are displayed and the outputs are enabled.

In order to operate appropriately, the controller needs a configuration that is the definition of each one of the several parameters presented by the controller. The user must be aware of the importance of each parameter and for each one determine a valid condition or a valid value.

**Note:** Since many parameters depend on the input type chosen, it is recommended that the parameter **TYPE** be the first one to be configured.

The parameters are grouped in levels according to their functionality and operation easiness. The 7 levels of parameters are:

LEVEL	ACCESS
1- Operation	Free access
2- Tuning	Reserved access
3- Programs	
4- Alarm	
5- Scale	
6- I/Os	
7- Calibration	

Table5 – Cycles of Parameters

The parameters in the operation level (1<sup>st</sup> level) are easily accessed through the **P** key. The access deeper levels use the combination of Keys:

**BACK and P (PROG) pressed simultaneously**

Press **P** to advance or **BACK** to retrocede parameters within a level. At the end of each level, the controller returns to the operation level. Keep pressing the **P** key to move fast forward in the level.

Alternatively, the controller returns to the operation level after pressing the **BACK** key for 3 seconds.

All configuration parameters are stored in protected memory. The values are saved when the keys **P** or **BACK** are pressed after changing a parameter value. The value of SP is saved upon pressing the **P** key or every 25 seconds.

**DESCRIPTION OF THE PARAMETERS**

PV Indication (Red Screen)	<p><b>PV / SP indication</b> - The upper display shows the current value of PV. The lower display shows the control SP value.</p>
SP Indication (Green Screen)	
<p><b>Auto</b> Control</p>	<p><b>Control Mode:</b>  <b>YES</b> - Means automatic control mode.  <b>no</b> - Means manual control mode.                      Bumpless transfer between automatic and manual.</p>
PV Indication (Red Screen)	<p><b>PV / MV</b>- The upper display shows <b>PV</b> value and the lower display shows the <b>percentage</b> of the manipulated variable <b>MV</b> applied to the control output.</p> <p>When in manual control, the <b>MV</b> value can be manually changed by the <b>▲</b> and <b>▼</b> keys. When in auto mode the <b>MV</b> value can only be viewed.</p> <p>To distinguish the <b>MV</b> display from the <b>SP</b> display, the <b>MV</b> is shown flashing intermittently.</p>
MV Indication (Green Screen)	
<p><b>Pr n</b> Enable Program</p>	<p><b>Execution of Program</b> - Selects the ramp and soak profile program to be executed.  <b>0</b> - does not execute program  <b>1 to 7</b> - number of the program to be executed</p> <p>With enabled outputs (<b>run = YES</b>), the program starts right after the program is selected.</p>
<p><b>run</b></p>	<p>Enables control outputs and alarms.  <b>YES</b> - Outputs enables.  <b>no</b> - Outputs not enabled.</p>

**CYCLE OF TUNING**

<p><b>Autun</b> Auto-tune</p>	<p>Enables the auto tuning feature for the PID parameters.  <b>YES</b> – Auto-tune enable  <b>no</b> – Do not execute auto tune.</p> <p>See the DETERMINATION OF PID PARAMETERS section for more details.</p>
<p><b>Pb</b> Proportional Band</p>	<p>Proportional Band - Value of the term <b>P</b> of the control mode PID, in percentage of the maximum span of the input type. Adjust of between 0 and 500.0 %.</p> <p><b>Select zero for ON/OFF control.</b></p>
<p><b>Ir</b> Integral Rate</p>	<p>Integral Rate - Value of the term <b>I</b> of the PID algorithm, in repetitions per minute (Reset). Adjustable between 0 and 24.00.</p> <p>Displayed only if proportional band ≠ 0.</p>
<p><b>dt</b> Derivative Time</p>	<p>Derivative Time - Value of the term <b>D</b> of the control mode PID, in seconds. Adjustable between 0 and 250 seconds.</p> <p>Displayed only if proportional band ≠ 0.</p>
<p><b>Ct</b> Cycle Time</p>	<p>Pulse Width Modulation (PWM) period in seconds. Adjustable between 0.5 and 100.0 seconds.</p> <p>Displayed only if proportional band ≠ 0.</p>
<p><b>HYSt</b> Hysteresis</p>	<p>Control hysteresis - This parameter is only shown for ON / OFF control. Adjustable between 0 and the measurement input type span.</p> <p>Displayed only if proportional band = 0.</p>

<p><b>Act</b> Action</p>	<p>Control logic:  <b>rE</b> Control with reverse Action. Appropriate for <b>heating</b>. Turns control output on when PV is below SP.  <b>dIr</b> Control with direct Action. Appropriate for <b>cooling</b>. Turns control output on when PV is above SP.</p>
<p><b>bIAS</b></p>	<p>Bias function - Allows adding a percentage value between -100 % and +100 % to the MV control output.                      The value 0 (zero) disables the function.</p>
<p><b>ouLL</b> Output Low Limit</p>	<p>Lower limit for the control output - Minimum percentage value assumed by the control output when in automatic mode and in PID.                      Typically configured with <b>0.0 %</b>.</p>
<p><b>ouHL</b> Output High Limit</p>	<p>Upper limit for the control output - Maximum percentage for the control output when in automatic mode and in PID.                      Typically configured with <b>100.0 %</b>.</p>
<p><b>SFSst</b> Softstart</p>	<p><b>SoftStart</b> Function – Time in seconds during which the controller limits the MV value progressively from 0 to 100 %. It is enabled at power up or when the control output is activated. If in doubt set zero (zero value disables the Soft start function).</p>
<p><b>SPA1</b> <b>SPA2</b> <b>SPA3</b> <b>SPA4</b></p>	<p>Alarm SP: Value that defines the point of activation for the programmed alarms with the functions "<b>Lo</b>" or "<b>Hi</b>".                      For the alarms configured with Differential type functions, this parameter defines deviation (band).                      Not used for the other alarm functions.</p>

**CYCLE OF PROGRAMS**

<p><b>tBAS</b> Program time base</p>	<p>Program time base - Defines the time base that will be used by all Ramp &amp; Soak programs.  <b>SEC</b> - Time basis in seconds  <b>min</b> - Time basis in minutes</p>
<p><b>Pr n</b> Program number</p>	<p>Selects the ramp and soak profile program to be edited/viewed. The sequence of parameters that follows refer to this selected program. Total of 20 programs possible. There are 7 possible programs.</p>
<p><b>Ptol</b> Program Tolerance</p>	<p>Maximum admitted deviation of PV with respect to SP. If exceeded, the program execution is suspended (the internal timer freezes) until the deviation returns back within the defined tolerance.                      The value 0 (zero) disables the function.</p>
<p><b>PSP0</b> <b>PSP7</b> Program SP</p>	<p>Program SP's, 0 to7: Group of 8 values of SP that define the Ramp and Soak profile segments.</p>
<p><b>Pt1</b> <b>Pt7</b> Program Time</p>	<p>Segments durations, 1 to7: Defines the time of duration, in second or minutes, 7 of the segments of the program being edited.</p>
<p><b>PE1</b> <b>PE7</b> Program event</p>	<p>Alarms of Event, 1 to 7: Parameters that define which alarms are to be activated during the execution of a certain program segment. The alarms chosen must have its function configured as "<b>rS</b>".</p>
<p><b>LP</b> Link Program</p>	<p>Link Program: number of the next profile program to be linked following the current program. Profiles can be linked together to produce larger programs of up to 49 segments.  <b>0</b> - do not link to any other program.  <b>1 a 7</b> - number of the program to be linked to.</p>

CYCLE OF ALARMS

<b>FJA1</b> <b>FJA2</b> <b>FJA3</b> <b>FJA4</b> Function Alarm	Functions of Alarms. Defines the functions for the alarms among the options of the Table 3. <b>oFF</b> , <b>IErr</b> , <b>rS</b> , <b>Lo</b> , <b>Hl</b> , <b>dIFL</b> , <b>dIFH</b> , <b>dIF</b>
<b>bLA1</b> <b>bLA2</b> <b>bLA3</b> <b>bLA4</b> Blocking Alarm	Block of Alarms. This function blocks the alarms1 to 4. <b>YES</b> - enables initial blocking <b>no</b> - inhibits initial blocking
<b>HYA1</b> <b>HYA2</b> <b>HYA3</b> <b>HYA4</b> Hysteresis of Alarm	Alarm Hysteresis. Defines the difference between the value of PV at which the alarm is triggered and the value at which it is turned off (in engineering units)..
<b>At1</b> <b>A2t1</b> Alarm Time t1	Defines the temporization time t1, for the alarms. In seconds. The value 0 (zero) disables the function.
<b>At2</b> <b>A2t2</b> Alarm Time t2	Defines the temporization time t2 for the alarms time functions. In seconds. The value 0 (zero) disables the function.

CYCLE OF SCALE



<b>TYPE</b> Type	INPUT TYPE: Selects the input signal type to be connected to the process variable input. Refer to Table 1 for the available options. This must be the first parameter to be configured.
<b>dPPO</b> Decimal Point	Defines the decimal point position.
<b>unit</b> Unit	UNIT: Defines the indication unit in Celsius "°C" or Fahrenheit "°F" This parameter is presented whenever a temperature sensor is configured as input.
<b>OFFS</b> Offset	SENSOR OFFSET: Offset value to be added to the PV reading to compensate sensor error. Default value: zero.
<b>SPLL</b> Setpoint Low Limit	Defines the SP lower limit of. For the linear analog input types available (0-20 mA, 4-20 mA, 0-50 mV and 0-5 V), defines the minimum PV indication range, besides limiting the SP adjustment. Defines lower limit for range retransmission PV and SP.
<b>SPHL</b> Setpoint High Limit	Defines the upper limit for adjustment of SP. For the linear analog input types available (0-20 mA, 4-20 mA, 0-50 mV and 0-5 V), defines the maximum PV indication range, besides limiting the SP adjustment. Defines upper limit for range retransmission PV and SP.
<b>ErSP</b> Enable Remote SP	Enables remote SP. <b>YES</b> Enables the Function <b>no</b> Does not enable the Function This parameter is not displayed when the remote SP selection is defined by a Digital Input.

<b>rSP</b> Remote SP	Defines the signal type for the remote SP. <b>0-20</b> current of 0-20 mA <b>4-20</b> current of 4-20 mA <b>0-5</b> voltage of 0-5 V <b>0-10</b> voltage of 0-10 V Parameter displayed when remote SP is enabled.
<b>rSLL</b> Remote SP Low Limit	REMOTE SETPOINT LOW LIMIT: used in conjunction with the <b>rSHL</b> , scales the remote SP input defining the initial value in the remote SP indication range. Parameter displayed when remote SP is enabled.
<b>rSHL</b> Remote SP High Limit	REMOTE SETPOINT HIGH LIMIT: defines the full scale indication of the Remote Setpoint. Parameter displayed when remote SP is enabled.
<b>BAud</b> Baud Rate	Serial Communication Baud Rate selection, in kbps: 1.2, 2.4, 4.8, 9.6, 19.2, 38.4, 57.6 e 115.2
<b>Prty</b> Parity	Parity of the serial communication. <b>nonE</b> Without parity <b>E:Er</b> Even parity <b>Odd</b> Odd parity
<b>Addr</b> Address	SLAVE ADDRESS SELECTION: Identifies the controller in the network. The possible address numbers are from 1 to 247.

CYCLE DE I/O S

<b>IO 1</b>	Function of the channel I/O 1: Selection of the function used in the channel I/O 1, according to the Table 2.
<b>IO 2</b>	Function of the channel I/O 2: Selection of the function used in the channel I/O 2, according to the Table 2.
<b>IO 3</b>	Function of the channel I/O 3: Selection of the function used in the channel I/O 3, according to the Table 2.
<b>IO 4</b>	Function of the channel I/O 4: Selection of the function used in the channel I/O 4, according to the Table 2.
<b>IO 5</b>	Function of the channel I/O 5: Selection of the function used in the channel I/O 5, according to the Table 2.

CALIBRATION CYCLE

All of the input and output types are calibrated in the factory. If a recalibration is required, this should be carried out by a experienced personnel. If this cycle is accidentally accessed, pass through all the parameters (without pressing the  or  keys) until the PV/SV screen is displayed

<b>PASS</b> Password	Input of the Access Password. This parameter is presented before the protected cycles. See item Protection of Configuration.
<b>CALib</b> Calibration?	Allows instrument calibration. <b>YES</b> - Perform calibration <b>no</b> - Do not perform calibration
<b>InLC</b> Input Low Calibration	Enter the value corresponding to the low scale signal applied to the analog input. See section MAINTENANCE / Input Calibration.
<b>InHC</b> Input High Calibration	Enter the value corresponding to the full scale signal applied to the analog input. See section MAINTENANCE / Input Calibration.

<b>rSLC</b> Remote SP Low Calibration	See section: MAINTENANCE / Input Calibration. Enter the value corresponding to the low scale signal applied to the remote SP input.
<b>rSHC</b> Remote SP High Calibration	See section: MAINTENANCE / Input Calibration. Enter the value corresponding to the full scale signal applied to the remote SP input.
<b>OUCL</b> Output Low Calibration	See section MAINTENANCE / Analog output Calibration. Enter the analog value as measured at the analog output.
<b>OUHC</b> Output High Calibration	See section MAINTENANCE / Analog output Calibration. Enter the analog value as measured at the analog output.
<b>rStr</b> Restore	Restores the factory calibration for all input, analog output and remote SP, disregarding modifications carried out by the user.
<b>CJ</b> Cold Junction	Adjusts the of cold junction temperature value.

<b>HTYP</b> Hardware Type	Parameter that informs the controller about the hardware optionals installed. It should not be altered by the user, except when an accessory is introduced or removed. 0 – Basic model, without optional I/Os, with or without RS485. 1 – 3R (485) 2 – DIO (3R)
<b>PASC</b> Password Change	Allows defining a new access password, always different from zero.
<b>Prot</b> Protection	Sets up the Level of Protection. See Table 6.

OPERATION CYCLE	TUNING CYCLE	PROGRAMS CYCLE	ALARM CYCLE	SCALE CYCLE	I/Os CYCLE	CALIBRATION CYCLE
PV / SP	<b>Autn</b>	<b>tbAS</b>	<b>FuA1 - FuA4</b>	<b>tYPE</b>	<b>Io1</b>	<b>PASS</b>
<b>Auto</b>	<b>Pb</b>	<b>Pr n</b>	<b>bLA1 - bLA4</b>	<b>dPPo</b>	<b>Io2</b>	<b>InLC</b>
PV / MV	<b>lr</b>	<b>PtoL</b>	<b>HYA1 - HYA4</b>	<b>un It</b>	<b>Io3</b>	<b>InHC</b>
<b>Pr n</b>	<b>dt</b>	<b>PSP0 -PSP7</b>	<b>A It1</b>	<b>aFF5</b>	<b>Io4</b>	<b>rSLC</b>
<b>run</b>	<b>Ct</b>	<b>Pt1 - Pt7</b>	<b>A It2</b>	<b>SPLL</b>	<b>Io5</b>	<b>rSHC</b>
	<b>HYSL</b>	<b>PE1 - PE7</b>	<b>A2t1</b>	<b>SPHL</b>		<b>OUCL</b>
	<b>Act</b>	<b>LP</b>	<b>A2t2</b>	<b>ErSP</b>		<b>OUHC</b>
	<b>bIAS</b>			<b>rSP</b>		<b>rStr</b>
	<b>ouLL</b>			<b>rSLL</b>		<b>CJ</b>
	<b>ouHL</b>			<b>rSHL</b>		<b>HTYP</b>
	<b>SFSL</b>			<b>bAud</b>		<b>PASC</b>
	<b>SPR1 - SPR4</b>			<b>Prty</b>		<b>Prot</b>
				<b>Addr</b>		

Table6 – All the controller parameter

### PROTECTION OF CONFIGURATION

The controller provides means for protecting the parameters configurations, not allowing modifications to the parameters values, avoiding tampering or improper manipulation.

The parameter Protection (**Prot**), in the Calibration level, determines the protection strategy, limiting the access to particular levels, as shown by the table below.

Protection Level	Protected Cycles
1	Only the Calibration level is protected.
2	I/Os and Calibration levels.
3	Tuning, I/Os and Calibration levels.
4	Alarm, Tuning, I/Os and Calibration levels.
5	Programs, Alarm, Tuning, I/Os and Calibration levels.
6	Tuning, Programs, Alarm, Input, I/Os and Calibration levels.
7	Operation (except SP), Tuning, Programs, Alarm, Scale, I/Os and Calibration levels.
8	Operation (including SP), Tuning, Programs, Alarm, Scale, I/Os and Calibration levels.

Table7 - Levels of Protection for the Configuration

### Access Password

The protected levels, when accessed, request the user to provide the Access Password for granting permission to change the configuration of the parameters on these cycles.

The prompt PASS precedes the parameters on the protected levels. If no password is entered, the parameters of the protected cycles can only be visualized.

The Access Code is defined by the user in the parameter Password Change (**PASC**), present in the Calibration level

The factory default for the password code is 1111.

### Protection of the access code

The protection system built into the controller blocks for 10 minutes the access to protected parameters after 5 consecutive frustrated attempts of guessing the correct password.

### Master Password

The Master Password is intended for allowing the user to define a new password in the event of it being forgotten. The Master Password doesn't grant access to all parameters, only to the Password Change parameter (**PASC**). After defining the new password, the protected parameters may be accessed (and modified) using this new password.



The master password is made up by the last three digits of the serial number of the controller **added** to the number 9000.

As an example, for the equipment with serial number 07154321, the master password is 9 3 2 1.

**PROGRAMS OF RAMP AND SOAK**

This feature allows the creation of Ramp and Soak Setpoint Profiles (Programs). Up to **7 different profiles with 7 segments** each can be programmed. Longer profiles of up to 49 segments can be created by linking 2 or more profiles together.

The figure below displays a profile model:

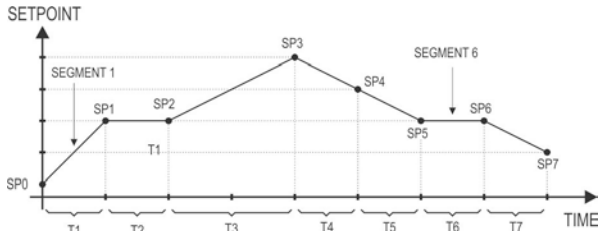

Figure 8 - Example of a Ramp and Soak program

Once a profile is defined and selected for execution, the controller starts to generate the SP profile automatically in accordance with the elaborated program.

To execute a profile with fewer segments just program 0 (zero) for the time intervals that follow the last segment to be executed.

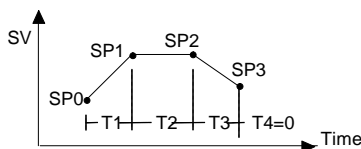

Figure 9 - Program example with few segments

The program tolerance "**Ptol**" defines the maximum deviation between PV and SP for the execution of the profile. If this deviation is exceeded, the program will be halted until the deviation falls to within the tolerance band.

Programming 0 (zero) in the "**Ptol**" parameter disables the program tolerance and the profile execution will continue regardless of the PV value (time priority as opposed to SP priority).

**LINK OF PROGRAMS**

It is possible to create a more complex program (up to 49 segments), joining two or more programs. This way, at the end of a program execution the controller immediately starts to run the next one, as indicated in the parameter "**LP**".

To force the controller to run a given program or many programs continuously, it is only necessary to link a program to itself or the last program to the first.

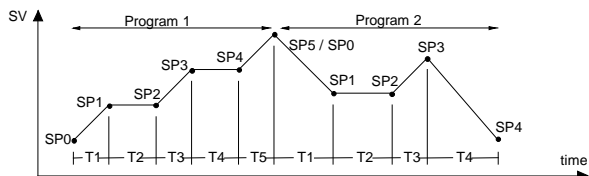

Figure 10 - Example of interlinked programs

**EVENT**

The Event Alarm function associates the alarms to specific segments of a program. The information of which alarms are to be activated or deactivated is given in parameters "**PE 1**" to "**PE 7**". Press the **▲** and **▼** keys until the desired alarm numbers are displayed.

The Event Alarm requires that the Alarm function be configured as "**r5**".

Notes:

1. If **Ptol** is different than zero, the controller will wait for the PV to reach the first program set point SP0 in order to start the program execution. Otherwise, it will start promptly.
2. Should any power failure occur, the controller resumes the program execution at the beginning of the segment where it was interrupted.

**DETERMINATION OF PID PARAMETERS**

During the **automatic tuning** the process is controlled in ON / OFF mode in the programmed SP. Depending on the process behavior, oscillations may occur above or below the Setpoint. The **automatic tuning** may take many minutes to be concluded, particularly in slow processes.

When the parameter **ATUN** is altered to YES, the **automatic tuning** is immediately initiated by the controller (provided RUN=YES, otherwise it will wait until this condition becomes true).

Some recommendations for the automatic tuning process are:

- **Auto** = YES: make sure the controller is set for automatic control mode.
- Disable Ramp & Soak programs configuring **Pr n** = 0. (the **automatic tuning** algorithm expects a stable Setpoint value)
- Select a Setpoint that is close or equal to the desired process Setpoint.
- Enable the **automatic tuning** (**Run** = YES).
- Enable outputs if not yet enabled (**run** = YES).

The "**TUNE**" indicator on the display stays lit until the completion of the **automatic tuning** process.

For control output types relay or pulse, the automatic tuning calculates the longest suitable period (cycle time **ct**) for the PWM output. The cycle time period may be reduced if the process experiences some oscillation. When driving a SSR, it's recommended to set **ct** = 1 s.

If the automatic tuning does not result in a satisfactory control, refer to Table 7 for guidelines on how to correct the behavior of the process.

PARAMETER	VERIFIED PROBLEM	SOLUTION
Proportional Band	Slow answer	Decrease
	Great oscillation	Increase
Rate of Integration	Slow answer	Increase
	Great oscillation	Decrease
Derivative Time	Slow answer or instability	Decrease
	Great oscillation	Increase

Table 7 - Guidance for manual adjustment of the PID parameters

**MAINTENANCE**

**PROBLEMS WITH THE CONTROLLER**

Connection errors and inadequate programming are the most common errors found during the controller operation. A final revision may avoid loss of time and damages.

The controller displays some messages to help the user identify problems.

MESSAGE	DESCRIPTION OF THE PROBLEM
----	Open input. No sensor or signal.
<b>Err 1</b> <b>Err 6</b>	Connection and/or configuration errors. Check the wiring and the configuration.

Other error messages may indicate hardware problems requiring maintenance service. When contacting the manufacturer, inform the instrument serial number, obtained by pressing the key **◀** for more than 3 seconds.

## CALIBRATION OF THE INPUT

All inputs are factory calibrated and recalibration should only be done by qualified personnel. If you are not familiar with these procedures do not attempt to calibrate this instrument.

The calibration steps are:

- Configure the type of input to be calibrated.
- Configure the lower and upper limits of indication for the maximum span of the selected input type.
- At the input terminals inject a signal corresponding to a known indication value a little above the lower display limit.
- Access the parameter "**InLc**". With the keys  $\blacktriangle$  and  $\blacktriangledown$ , adjust the display reading such as to match the applied signal. Then press the  $\text{P}$  key.
- Inject a signal that corresponds to a value a little lower than the upper limit of indication.
- Access the parameter "**InHc**". With the keys  $\blacktriangle$  and  $\blacktriangledown$ , adjust the display reading such as to match the applied signal. Then press the  $\text{P}$  key.

**Note:** When checking the controller calibration with a Pt100 simulator, pay attention to the simulator minimum excitation current requirement, which may not be compatible with the 0.170 mA excitation current provided by the controller.

## REMOTE SETPOINT CALIBRATION

All inputs are factory calibrated and recalibration should only be done by qualified personnel. If you are unfamiliar with these procedures do not attempt to calibrate this instrument.

If the recalibration or the remote Setpoint is required, proceed as follows.

- Configure the remote Setpoint type to be calibrated.
- Program the low and high limits of the remote Setpoint to the minimum and maximum values respectively.
- Apply to the remote Setpoint input a known signal that is slightly above the low limit of that input.
- At the parameter "**rSLC**" use the  $\blacktriangle$  and  $\blacktriangledown$  keys to show in the display the corresponding value of the applied signal. Then press the  $\text{P}$  key.
- Apply to the remote Setpoint input a known signal that is slightly below the high limit of that input.
- At the parameter "**rSHC**" use the  $\blacktriangle$  and  $\blacktriangledown$  keys to show in the display the corresponding value of the applied signal. Then press the  $\text{P}$  key.

## ANALOG OUTPUT CALIBRATION

- Configure **I/O 5** for the current output to be calibrated, be it control or retransmission.
- In the screen "**ctrl**", program manual mode (**rAn**).
- Connect a current meter at the analog output.
- Enter the calibration cycle with the correct password.
- Select the screen "**ouLc**". Press the  $\blacktriangle$  and  $\blacktriangledown$  keys for the controller to recognize the calibration process of the current output.
- Read the current indicated on the current meter and adjust the parameter "**ouLc**" to indicate this current value (use the  $\blacktriangle$  and  $\blacktriangledown$  keys)
- Select the screen "**ouHc**". Press the  $\blacktriangle$  and  $\blacktriangledown$  keys for the controller to recognize the calibration process of the current output.
- Read the current indicated on the current meter and adjust the parameter "**ouHc**" to indicate this current value
- Press the  $\text{P}$  key in order to confirm the calibration procedure and return to the operating level.

## SERIAL COMMUNICATION

The controller can be supplied with an asynchronous RS-485 digital communication interface for master-slave connection to a host computer (master).

The controller works as a slave only and all commands are started by the computer which sends a request to the slave address. The addressed unit sends back the requested reply.

Broadcast commands (addressed to all indicator units in a multi drop network) are accepted but no reply is sent back in this case.

## CHARACTERISTICS

- Signals compatible with RS-485 standard. MODBUS (RTU) Protocol. Two wire connection between 1 master and up to 31 (addressing up to 247 possible) instruments in bus topology. The communication signals are electrically insulated from the rest of the device;
- Maximum connection distance: 1000 meters.
- Time of disconnection for the controller: Maximum 2 ms after last byte.
- Selectable speed; 8 data bits; 1 stop bit; selectable parity (no parity, pair or odd);
- Time at the beginning of response transmission: maximum 100 ms after receiving the command.

The RS-485 signals are:

D1	D	D +	B	Bi-directional data line.	Terminal 16
D0	$\bar{D}$ :	D -	A	Bi-directional inverted data line.	Terminal 17
C				Optional connection that improves the performance of the communication.	Terminal 18
GND					

## CONFIGURATION OF PARAMETERS FOR SERIAL COMMUNICATION

Three parameters must be configured for using the serial type:

**bAud:** Communication speed.

**Prty:** Parity of the communication.

**Addr:** Communication address for the controller.

## REDUCED REGISTERS TABLE FOR SERIAL COMMUNICATION

### COMMUNICATION PROTOCOL

The MOSBUS RTU slave is implemented. All configurable parameters can be accessed for reading or writing through the communication port. Broadcast commands are supported as well (address 0).

The available Modbus commands are:

03 - Read Holding Register

06 - Preset Single Register

05 - Force Single Coil

16 - Preset Multiple Register

### HOLDING REGISTERS TABLE

Follows a description of the usual communication registers. For full documentation download the **Registers Table for Serial Communication** in the N1100 section of our web site – [www.novusautomation.com](http://www.novusautomation.com).

All registers are 16 bit signed integers.

Address	Parameter	Register Description
0000	Active SP	Read: Active control SP (main SP, from ramp and soak or from remote SP). Write: to main SP. Range: from <b>SPLL</b> to <b>SPHL</b> .
0001	PV	Read: Process Variable. Write: Not allowed. In case of temperature reading, the value read is always multiplied by 10, independently of <b>dPPo</b> value.
0002	MV	Read: Output Power in Automatic or Manual mode. Write: only allowed when in Manual mode. Range: 0 to 1000 (0.0 to 100.0 %).

## SPECIFICATIONS

**DIMENSIONS:**..... 48 x 48 x 110 mm (1/16 DIN)  
.....Approximate Weight: 150 g

**CUTOUT IN THE PANEL:**.....45.5 x 45.5 mm (+0.5 -0.0 mm)

**POWER SUPPLY:**.....100 to 240 Vac/dc ( $\pm 10\%$ ), 50/60 Hz  
Optionally:..... 24 Vac/dc  $\pm 10\%$   
Maximum consumption:..... 9 VA

### ENVIRONMENTAL CONDITIONS:

Operation Temperature: ..... 5 to 50 °C  
Relative Humidity:..... 80 % max. up to 30 °C  
For temperatures above 30 °C, reduce 3 % for each °C  
Internal Use; Category of installation II, Degree of pollution 2;  
altitude < 2000 m.

**INPUT** .....T/C, Pt100, voltage and current (according to Table 1)

**Internal Resolution:**..... 32767 levels (15 bits)

**Resolution of Display:**..... 12000 levels (from -1999 up to 9999)

**Rate of input reading:**..... up to 55 per second

**Precision:** ..Thermocouples J, K, T, E: 0.25 % of the *span*  $\pm 1$  °C

.....Thermocouples N, R, S, B: 0.25 % of the *span*  $\pm 3$  °C

.....Pt100: 0.2 % of the *span*

..... 4-20 mA, 0-50 mV, 0-5 Vdc: 0.2 % of the *span*

**Input Impedance:** .0-50 mV, Pt100 and thermocouples: >10 M $\Omega$

..... 0-5 V: >1 M $\Omega$

..... 4-20 mA: 15  $\Omega$  (+2 Vdc @ 20 mA)

**Measurement of Pt100:** ..... Three wires type, ( $\alpha=0.00385$ )  
with compensation for cable length, excitation current of 0.170 mA.

All input and output types are factory-calibrated. Thermocouples according to standard NBR 12771 / 99, RTD's NBR 13773 / 97;

**ANALOGICAL OUTPUT (I/O5):**.....0-20 mA or 4-20 mA, 550  $\Omega$  max.  
.....31000 levels, Isolated, for control or retransmission of PV and SP.

### CONTROL OUTPUT:

2 Relays SPST-NA (I/O1 and I/O2): 1.5 A / 240 Vac, general use

.....1 Relay SPDT (I/O3): 3 A / 250 Vac, general use

..... Voltage pulse for SSR (I/O5): 10 V max. / 20 mA

..... Voltage pulse for SSR (I/O3 and I/O4): 5 V max. / 20 mA

**INPUT OF REMOTE SP:**..... 0-20 mA, 4-20 mA, 5 V, 10 V

The Remote SP mA inputs require an external resistor of 100 R connected directly to the terminals 9 and 10 of the controller's back panel.

**ELECTROMAGNETIC COMPATIBILITY:** ..... EN 61326-1:1997 and EN 61326-1/A1:1998

**SAFETY:** ..... EN61010-1:1993 and EN61010-1/A2:1995

**USB INTERFACE 2.0, CDC CLASS (VIRTUAL COMMUNICATIONS PORT), MODBUS RTU PROTOCOL.**

**SPECIFIC CONNECTIONS FOR TYPE FORK TERMINALS OF 6.3 mm;**

**FRONT PANEL:** IP65, POLYCARBONATE - UL94 V-2;

**CASE:** IP20, ABS+PC UL94 V-0;

**PROGRAMMABLE CYCLE OF PWM 0.5, UP TO 100 SECONDS;**  
**STARTS UP OPERATION AFTER 3 SECONDS CONNECTED TO THE POWER SUPPLY;**

**CERTIFICATIONS:** ..... CE / UL (FILE: E300526)

## IDENTIFICATION

N1100 -	3R -	485 -	24V
A	B	C	D

A: Controller model:

**N1100;**

B: Optional I/Os:

**Blank:** (basic version, without I/O3 nor I/O4);

**3R** (SPDT Relay in I/O3);

**DIO** (Digital I/Os in I/O3 and I/O4);

C: Digital Communication:

**Blank** (basic version, without serial communication);

**485** (RS485, Modbus protocol)

D: Power Supply:

**Blank** (basic version, 100 to 240 Vac/dc);

**24V** (24 Vac/dc input voltage);

## SAFETY INFORMATION

Any control system design should take into account that any part of the system has the potential to fail. This product is not a protection or safety device and its alarms are not intended to protect against product failures. Independent safety devices should be always provided if personnel or property are at risk.

Product performance and specifications may be affected by its environment and installation. It's user's responsibility to assure proper grounding, shielding, cable routing and electrical noise filtering, in accordance with local regulations, EMC standards and good installation practices.