



Controller N2000S

UNIVERSAL PROCESS CONTROLLER – INSTRUCTIONS MANUAL – V2.1x

SAFETY SUMMARY

The symbols below are used on the equipment and throughout this document to draw the user's attention to important operational and safety information.

<p>CAUTION OR WARNING: Read complete instructions prior to installation and operation of the unit.</p>	<p>CAUTION OR WARNING: Electrical Shock Hazard</p>

All safety related instructions that appear in the manual must be observed to ensure personal safety and to prevent damage to either the instrument or the system. *If the instrument is used in a manner not specified by the manufacturer, the protection provided by the equipment may be impaired.*

INTRODUCTION

N2000S is a controller for servo positioners with two control relays: one to open and other to close the valve (or damper). Moreover, it has an analog output that can be programmed to control or retransmit input or setpoint signals. Its universal input accepts most industry manufactured sensors and signals.

Configuration can be entirely achieved through the keyboard, no circuit changes are required. Selection of input and output type, alarms configuration, and other especial functions are accessed and programmed through the frontal panel.

It is important that you read the manual thoroughly before using the controller. Be sure the manual corresponds to your instrument (the number of the software version can be seen when the controller is turned on).

CHARACTERISTICS

- Sensor break protection in any condition; Universal multi-sensor input without hardware change;
- Potentiometer input for current position reading;
- Auto-tuning of PID parameters;
- Control outputs: relays;
- Automatic/Manual "bumpless" transfer;
- Two alarm outputs; functions: minimum, maximum, differential (deviation), open sensor and event. Two-alarm temporization;
- 4-20 mA or 0-20 mA analog output for Process Variable (PV) or SetPoint (SP) retransmission;
- 4-function digital input;
- Ramp and soak with 7 programs of 7 segments with linking capability;
- RS-485 serial communication; RTU MODBUS protocol;
- Configuration protection;

PRESENTATION / OPERATION

The controller frontal panel is shown in Figure 1:

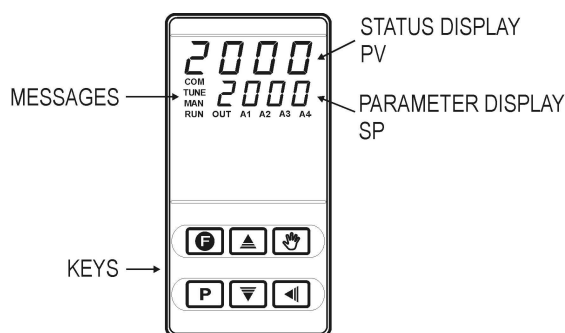

Figure 1 – Frontal panel

PV/Programming Display: Shows the PV value. When in programming mode, shows the parameter name.

SP/Parameters Display: Shows the SP and other programmable parameter values of the controller.

COM Indicator: Flashes when data is exchanged with the external environment.

TUNE Indicator: Lights during automatic tuning.

MAN Indicator: Indicates that the controller is in the manual control mode.

RUN Indicator: Indicates that the controller is active, with control and alarm outputs enabled.

OUT Indicator: When the analog output (0-20 mA or 4-20 mA) is set for controlling actions the indicator lights continuously.

A1, A2 Indicators: Indicates the respective alarm status.

A3 Indicators: Indicates the valve (I/O3) opening output status.

A4 Indicators: Indicates the valve/dumper (I/O4) closing output status.

[P] PROG key: Shows the controller programmable parameters.

[←] BACK Key: Returns to the previous parameter shown in the parameter display.

[▲] Increase and [▼] Decrease keys: Change the parameter values.

[Auto/Man] Auto/Man key: Shortcut for automatic/manual control selection. Alternates the control mode between automatic and manual each time the key is pressed.

[F] Programmable Function Key: Can be assigned to the special functions described for the **FFunc** parameter.

When the controller is turned on, its firmware version is displayed for 3 seconds, after that the controller starts operating normally. The PV and SV values are displayed in the upper and lower displays respectively. Outputs are enabled at this moment as well.

The relay associated to the valve closing is activated during the time required for the complete valve to close (see parameter "**SEr.t**") so that the controller starts operating with a known reference.

To run smoothly, the controller requires some basic configuration:

- Input type (Thermocouples, Pt100, 4-20 mA, etc.).
- Control setpoint value (SP).
- Control output type (relays, 0-20 mA, pulse).
- PID parameters (or hysteretic for ON / OFF control).

Other special functions, including ramp and soak, alarm timer, digital input, etc., can be used to achieve better performance.

The setup parameters are grouped in cycles, in which each message is a parameter to be defined. The 7 parameter cycles are:

CYCLE	ACCESS
1 - Operation	Free
2 - Tuning	Reserved access
3 - Programs	
4 - Alarms	
5 - Input configuration	
6 - I/Os	
7 - Calibration	

The operation cycle (1st cycle) is freely accessed. The other cycles require a keystroke combination to enable access.

Press **◀** (BACK) and **P** (PROG) simultaneously

When the required cycle is found, all the parameters within this cycle can be accessed by pressing the **P** key (or **◀**, to go backwards). To return to the operation cycle, press **P** many times up to all parameters of the current cycle have been shown.

All parameters set up are stored in a protected memory. Changed values are automatically saved when the user goes to the next parameter. The SP value is saved when parameters are changed or at every 25 seconds.

CONFIGURATION PROTECTION

The parameter values can be locked after configuration is finished thus preventing undesirable changes. Parameters can be seen but not changed. Protection is activated by a combination of keystrokes and an internal key.

Press **▲** and **◀** simultaneously for 3 seconds, in the cycle you want to protect.

To unlock a cycle press **▼** and **◀** simultaneously for 3 seconds.

Displays will flash briefly to confirm locking or unlocking operation.

Within the controller, the **PROT** key completes the locking function. When PROT is OFF the user is allowed to lock and unlock the cycles. When PROT is ON changes are not allowed: if cycles are protected protection cannot be removed, if there aren't cycles protection, they cannot be made.

CONTROL OPERATION

The controller is based on the "**SErT**" parameter (Time of serve excursion). This is the time the serve requires to open completely when it is in the closed position. The output percentage calculated by the PID (0 to 100 %) is transformed into the serve activation time to reach a relative position.

A new output value of the PID is calculated at every 250 ms. The "**SErF**" parameter defines the time in seconds for the calculation and activation of a new output value. This parameter works as a filter, it makes the output slower and increases the time intervals.

The minimum resolution for a new position change is given by the parameter "**SErR**". If the difference between the current output value and the new value calculated by the PID is lower than the programmed percentage of this parameter, no activation is performed.

If the calculated output is between 0 % or 100 % and it is maintained for some time, the opening relay (when in 0 %) or the closing relay (when in 100 %) will be periodically activated for a time fraction to assure that the real position is close to the estimated position, for mechanical problems or non-linearity of the process.

CONFIGURATION / RESOURCES

INPUT TYPE SELECTION

The input type must be selected by the user in the "**TYPE**" parameter using the keyboard (see input types in Table 1).

TYPE	CODE	FEATURES
J	0	Range: -50 to 760 °C (-58 to 1400 °F)
K	1	Range: -90 to 1370 °C (-130 to 2498 °F)
T	2	Range: -100 to 400 °C (-148 to 752 °F)
N	3	Range: -90 to 1300 °C (-130 to 2372 °F)
R	4	Range: 0 to 1760 °C (32 to 3200 °F)
S	5	Range: 0 to 1760 °C (32 to 3200 °F)
Pt100	6	Range: -199.9 to 530.0 °C (-199.9 to 986.0 °F)
Pt100	7	Range: -200 to 530 °C (-328 to 986 °F)
4-20 mA	8	J Linearization. Programmable range: -110 to 760 °C
4-20 mA	9	K linearization Programmable range: -150 to 1370 °C
4-20 mA	10	T linearization. Programmable range: -160 to 400 °C
4-20 mA	11	N linearization Programmable range: -90 to 1370 °C
4-20 mA	12	R linearization Programmable range: 0 to 1760 °C
4-20 mA	13	S linearization Programmable range: 0 to 1760 °C
4-20 mA	14	Pt100 linearization. Prog. range: -200.0 to 530.0 °C
4-20 mA	15	Pt100 linearization. Prog. range: -200 to 530 °C
0 – 5 0 mV	16	Linear. Programmable indication from -1999 to 9999.
4-20 mA	17	Linear. Programmable indication from -1999 to 9999.
0 – 5 Vdc	18	Linear. Programmable indication from -1999 to 9999.
4-20 mA	19	Input square root extraction

Table 1 – Input types

Note: All available input types are factory calibrated.

I/O CHANNELS CONFIGURATION

The controller input/output channels can undertake multiple functions: Control output, digital input, digital output, alarm output, PV and SP retransmission. These channels are identified as **I/O 1**, **I/O2**, **I/O 3**, **I/O 4**, **I/O 5** and **I/O6**.

The function code of each I/O can be selected among the following options. Only valid function codes are displayed for each I/O.

I/O 1 and I/O2 – used as ALARM outputs

Two SPDT relays are available in terminals 7 to 12. They can be assigned codes **0**, **1** or **2**.

- 0** - Disables the alarm;
- 1** - Defines channel as alarm 1;
- 2** - Defines channel as alarm 2;

I/O 3 and I/O4 – used as CONTROL outputs

Two SPST relays, available in terminals 3 to 6. They are assigned code 5.

- 5** – Defines channel as control output.

I/O 5 – Analog output and digital input

0-20 mA or 4-20 mA analog channel output used to retransmit PV and SP values, or perform functions of digital input and output. They can be assigned codes 0 to 16.

- 0** – No function (disabled);
- 1** – Defines channel as alarm 1;
- 2** – Defines channel as alarm 2;
- 3** – Invalid selection;
- 4** – Invalid selection;
- 5** – Invalid selection;
- 6** - Digital input, manual/automatic selection:
 - Closed = manual control;
 - Open = automatic control

- 7- Digital input, Start/Stop control ("run": YES / no).
 Closed = outputs enabled
 Open = outputs disabled
- 8- Invalid selection;
- 9- Digital input, holds or allows R&S program progress.
 Closed = enables program running;
 Opened = holds program (the program resumes normal operation when the contact is closed again. The program resumes from the point it was prior to the hold)
- 10- R&S program 1 selection. This option is useful when the user wants to switch between the main setpoint and a second SP defined in the ramp and soak program.
 Closed = selects program 1;
 Open = assumes the main setpoint
- 11- Configures the I/O5 as an analog 0-20 mA control output.
- 12- Configures the I/O5 as an analog 4-20 mA control output.
- 13- Analog 0-20 mA retransmission of PV.
- 14- Analog 4-20 mA retransmission of PV.
- 15- Analog 0-20 mA retransmission of SP.
- 16- Analog 4-20 mA retransmission of SP.

I/O 6 – Digital Input

- 0- Disable the alarm;
- 6- Digital input, manual/automatic selection:
 Closed = manual control;
 Open = automatic control
- 7- Start/Stop control ("run": YES / no).
 Closed = outputs enabled
 Open = outputs disabled
- 8- Invalid selection;
- 9- Holds or allows R&S program progress.
 Closed = enables program running;
 Opened = holds the program (the program resumes normal operation when the contact is closed again)
- 10- R&S program 1 selection. This option is useful when the user wants to switch between the main setpoint and a second SP defined in the ramp and soak program.
 Closed = selects program 1;
 Open = takes the main setpoint

Note: When a function is selected to operate through digital input, the controller does not respond to the equivalent function command given in the frontal keypad.

POTENTIOMETER INPUT

The potentiometer of valve position can be seen in the controller. It must be 10 kΩ and connections must be as Figure 07 shows. The potentiometer reading does not power the valve position for control effects, it only informs the operator the valve current position. The control action happens regardless of the potentiometer.

In order to visualize the potentiometer reading, the "Pot" parameter must be enabled. When enabled (YES), the potentiometer position is displayed on the prompt screen that shows the Manipulated Variable (MV). When the potentiometer visualization is selected, the MV is not shown anymore, and the percentage value of valve opening is shown instead. The MV screen is the second prompt of the main cycle.

ALARM CONFIGURATION

The controller has 2 independent alarms. They can be programmed to operate with nine different functions, represented in Table 3.

- Open sensor
 It is activated whenever the input sensor is broken or disconnected.
- Event alarm
 It activates alarm(s) in specific segments of the program. See item 7.2 in this manual.

- Resistance fail
 Detects a heater broken condition, by monitoring the load current when the control output is activated. This alarm function requires an optional device (option 3). Details of the "resistance fail" option can be found in a specific documentation that is sent with the product when the option is purchased.

TYPE	PROMPT	ACTION
Disabled	oFF	No active alarm. This output can be used as a digital output to be set by the serial communication.
Sensor Break (input Error)	iErr	Alarm will be ON if PV sensor breaks, input signal is out of range or Pt100 is shorted.
Event Alarm (ramp and Soak)	rS	Can be activated at a specific segment of ramp and soak program.
Detection resistance fail	rFR IL	Detects a heater broken condition
Low Alarm	Lo	
High Alarm	Hi	
LOW Differential	dIFL	
HIGH Differential	dIFH	
Differential	dIF	

Table 3 – Alarm functions

SPAN is meant to be the Alarm Setpoints "SPA1", "SPA2".

- Minimum value
 It is activated when the measured value is below the value defined in the alarm Setpoint.
- Maximum value
 It is activated when the measured value is above the value defined in the alarm Setpoint.
- Open sensor
 It is activated whenever the input sensor is broken or disconnected.
- Event alarm
 It activates alarm(s) in specific segments of the program. See item 7.2 in this manual.
- Resistance fail
 Detects a heater broken condition, by monitoring the load current when the control output is activated. This alarm function requires an optional device (option 3). Details of the "resistance fail" option can be found in a specific documentation that is sent with the product when the option is purchased.
- Minimum value
 It is activated when the measured value is below the value defined in the alarm Setpoint.
- Maximum value
 It is activated when the measured values is above the value defined in the alarm Setpoint.
- Differential (or Band)
 In this function, the parameters "SPR 1", "SPR2" represent the PV deviation as compared to the main SP.
 In a positive deviation, the differential alarm will be triggered when the measured value is **out** of the range defined in:
(SP – Deviation) and (SP + Deviation)
 In a negative deviation, the differential alarm will be triggered when the measured value is **within** the range defined above.

- Minimum differential
It is activated when the measured value is below the value defined in:
(SP - Deviation)
- Maximum differential
It is activated when the measured value is above the value defined in:
(SP + Deviation)

ALARM TIMER

Alarms can be programmed to have timer functions. The user can delay alarm activation, set one pulse per activation, or make the alarm signals operate in sequential pulses. Alarm timer is available only for alarms 1 and 2 when "R1t1", "R1t2", "R2t1" and "R2t2" parameters are programmed.

Figures shown in Table 4 represent these functions, t1 and t2 may vary from 0 to 6500 seconds and their combinations define the timer mode. For normal operation, with no alarm timer activation, t1 and t2 must be assigned 0 (zero).

The LEDs associated to the alarms will flash whenever an alarm condition is acknowledged, regardless the actual state of the output relay, which may be temporarily off because of temporization.

ALARM INITIAL BLOCKING

The initial blocking option prevents the alarm from being recognized if an alarm condition is present when the controller is turned off for the first time. The alarm could be activated only after the occurrence of a non-alarm condition followed by a new occurrence of an alarm condition. The initial blocking is useful, for example, when one of the alarms is programmed as minimum value alarm, which can trigger the alarm at the system startup. This is not always required.

The initial blocking is disabled for the open sensor function.



ALARM FUNCTION	t1	t2	ACTION
Normal	0	0	Alarm Output 
Delayed	0	1 to 6500 s	Alarm Output 
Pulse	1 to 6500 s	0	Alarm Output 
Oscillator	1 to 6500 s	1 to 6500 s	Alarm Output 

Table 4 – Temporization functions for Alarms 1 and 2

PV AND SP ANALOG RETRANSMISSION

The controller has an analog output (I/O5) that can make a 0-20 mA or 4-20 mA retransmission proportional to the PV or SP values assigned. The analog retransmission is scalable, this means it has max. and min. limits that define the output range, which can be defined in parameters "SPLL" and "SPHL".

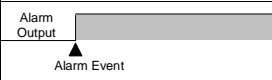
To obtain voltage retransmission the user must install a shunt resistor (550 Ω max.) in the analog output terminal. The resistor value depends on the voltage range required.

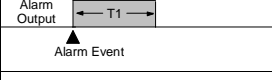
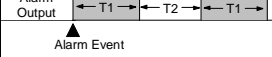
KEY FUNCTIONS

F key (special function key) in the frontal panel of the controller can perform the same function as the Digital Input I/O6 (except function 5). The key function is defined by the user in the "FFun" parameter:

- 0** - Disables the alarm;
- 7** - Defines the channel for the digital input and turns off the ("run": YES / no) control.
Closed = enabled outputs
Open = control output and alarms turned off;
- 8** - Invalid selection;

9 - Defines the channel that will command programs execution

- Closed = enables program execution
- Open = interrupts program

Note: When the program is interrupted, execution is held (the control remains active). The program resumes when the signal applied to the digital input allows it (closed contact).

I0 - Defines channel to select program 1. This option is useful when the user wants to switch between the main setpoint and a second one defined in the program of ramp and soak.

- Closed = selects program 1;
- Open = takes the main setpoint

Note: When a function is selected to operate through digital input, the controller does not respond to the equivalent function command given in the frontal keypad.

KEY

The **F** key is located in the frontal panel. It performs function 6 of the digital input I/O6: switch between automatic and manual control.

Operation of this key is enabled in parameter **Run**.

The MAN indicator flashes when the manual control mode is selected.

INSTALLATION / CONNECTIONS

PANEL MOUNTING

The controller must be panel-mounted following the steps presented below:

1. Make the panel slot;
2. Remove fixing brackets;
3. Insert the controller into the panel slot;
4. Replace the clamps in the controller pressing it to reach a firm grip at the panel.

ELECTRICAL CONNECTIONS

It is not necessary to disconnect the rear panel terminals to remove the internal circuit. Figure 2 shows how signals are distributed in the controller rear panel.

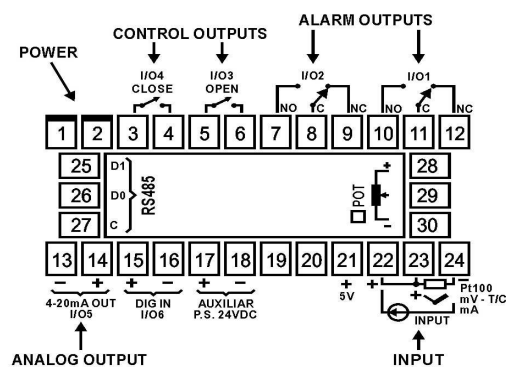

Figure 2 – Rear panel terminals

INSTALLATION RECOMMENDATIONS

- Conductors of input signals must be distant from activation or high-tension/current conductors, preferably passing through grounded conduits.
- A specific electrical power supply network should be provided for instruments use only.
- In controlling and monitoring applications, possible consequences of any system failure must be considered in advance. The internal relay alarm does not provide total protection.
- RC filters (for noise reduction) in inductor charges (contactors, solenoids, etc.) are recommended.

INPUT CONNECTIONS

It is important that they are very well connected; the sensor wires must be well fixed in the terminals of the rear panel.

- Thermocouple (T/C) and 50 mV:

Figure 3 shows how connections are made. If extension of the thermocouple is required, proper compensation cables should be provided.

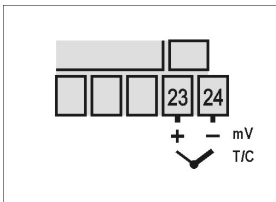

Figure 3 – Thermocouple and 0-50 mV

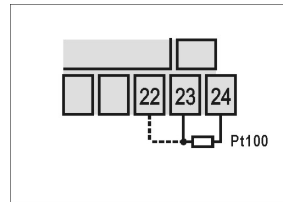

Figure 4 – Pt100 wiring with three conductors

- RTD (Pt100):

Figure 4 shows the Pt100 wiring for 3 conductors. Terminals 22, 23, and 24 must have the same wire resistance for proper cable length compensation (use conductors with the same gauge and length). In case the sensor has 4 wires, one should be left loose near the controller. For 2-wire Pt100, short circuit terminals 22 and 23.

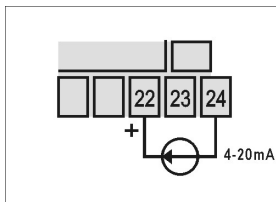

Figure 5 – Connection of 4-20 mA

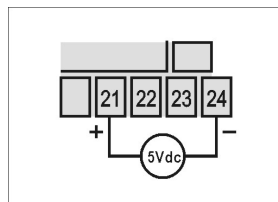

Figure 6 – Connection of 5 Vdc

- 4-20 mA: Figure 5 shows the 4-20 mA current signals wiring.
- 0-5 Vdc: Figure 6 shows the 0-5 Vdc voltage signals wiring.
- Alarm and output connection

When I/O channels are set up as output channels, they must have their capacity respected, according to specifications.

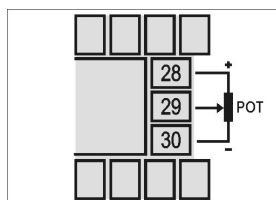

Figure 7 – Potentiometer connection

CONFIGURATION PARAMETERS

OPERATION CYCLE

PV Indication (Red)	PV and SP indication: The upper status display shows the current value of PV. The lower parameter display shows SP value of automatic control mode.
SV Indication (Green)	The upper display shows “- - -” whenever PV exceeds the maximum range or there is no signal at the input. In case of hardware error the status display will show “Er n”, where n is the error code.
PV Indication (Red)	MANIPULATED VARIABLE VALUE (MV) (control output): The upper display shows PV value and the lower display shows the percentage of MV applied to the control output. When in manual control, the MV value can be changed. When in auto mode, the MV value is only for visualization. To distinguish the MV display from the SP display, the MV flashes intermittently.
MV Indication (Green)	

Pr n Program number	PROGRAM EXECUTION: Selects the ramp and soak program to be executed. 0 – does not run program 1, 2, 3, 4, 5, 6 and respective program. When the control is enabled, the program selected runs immediately. In the program cycle of ramp and soak there is a parameter with the same name. In that context, the parameter is associated with the number of the program that will run.
run	ENABLES CONTROL AND ALARMS OUTPUT: YES - control and alarm enabled; NO - control and alarms disabled.

TUNING CYCLE

Autn	(Auto-tune) – auto tune of PID parameters. See item 9 in this manual. YES – Enables auto tune. NO – Disables auto tune.
Pb	(Proportional band) – PROPORTIONAL BAND: P term value of the PID control, percentage of maximum input type span. Adjustable between 0 and 500 % if adjusted to zero, control is ON/OFF.
HYSt	(HYSteresis) – CONTROL HYSTERESIS: Hysteresis value for ON/OFF control. This parameter is shown only for ON/OFF control (Pb=0).
ir	(integral rate) – INTEGRAL RATE: Value of I term of PID control in repetitions per minute (Reset). Adjustable between 0 and 24.00. Presented if proportional band ≠ 0.
dt	(derivative time) - DERIVATIVE TIME: Value of D term of the PID control in seconds. Adjustable between 0 and 250 s. Presented if proportional band ≠ 0.
SErt	(Servo time) – time of servo excursion, from totally open to totally closed. Programmable from 15 to 600 s.
SErr	(Servo resolution) – control resolution, determines the dead band of servo activation. Very low values (<1 %) make the servo “nervous”
SErF	(Servo filter) – PID output filter, before use by the servo control. It is the time the PID mean is made, in seconds. The output is only activated after this time. Recommended value: > 2 s.
Rct	(Action) – CONTROL ACTION: Only in the automatic control mode Reverse action (“rE”) usually used for heating; Direct action (“rE”) usually used for cooling
SPA1 SPA2	(SetPoint of Alarm) – ALARM SP: Value that defines the trigger point of alarms programmed with the “Lo” or “Hi” functions. In alarms programmed with the function Differential this parameter defines the deviation. See item 5.3. It is not used in other alarm functions.

PROGRAM CYCLE

tBAS	TIME BASE: Selects the time base for the ramp and soak. Valid for all profile programs. B - PT1 to PT7 values are in seconds; I - PT1 to PT7 values are in minutes;
Pr n	(Program number) – PROGRAM EDITING: Selects the ramp and soak program to be edited in the next prompts of this cycle.
PtoL	(Program tolerance) – PROGRAM TOLERANCE: Maximum deviation between PV and SP. Whenever this deviation is exceeded the time counter is halted until deviation lowers to acceptable values. Set zero to disable this function.
PSP0 PSP7	(Program SetPoint) – PROGRAM SPs, 0 TO 7: Set of 8 SP values that define the ramp and soak program profile (see item 8).

Pt 1 Pt 7	(Program time) – PROGRAM SEGMENTS TIME, 1 to 7: Defines elapsed time in minutes of each segment of the program (see item 8).
PE 1 PE 7	(Program event) - EVENT ALARMS, 1 to 7: Parameters that define which alarms must be triggered while a program segment is running, according to codes from 0 to 3 presented in Table 6. Alarm function depends on "rS" setting.
LP	(Link to Program) - LINK TO PROGRAM: Number of the next program to be connected. Programs can be linked to generate profiles of up to 49 segments (see item 8.1). 0 – do not connect to any other program 1 – connect to program 1 2 – connect to program 2 3 – connect to program 3 4 – connect to program 4 5 – connect to program 5 6 – connect to program 6 7 – connect to program 7

SPHL	(SetPoint High Limit) – SETPOINT HIGHER LIMIT For linear inputs, selects the maximum value of indication and adjustment for parameters related to PV and SP. For thermocouples and Pt100, selects the maximum value for SP adjustment. Defines also the higher limit value for retransmission of PV and SP.
Pot	(Potentiometer) – Selects value that will be displayed in the MV screen (the second screen of the main cycle). YES - Shows the potentiometer value no - Shows the PID output
bAud	COMMUNICATION BAUD RATE Available with RS485. 0=1200 bps; 1=2400 bps; 2=4800 bps; 3=9600 bps; 4=19200 bps
Addr	(Address) - COMMUNICATION ADDRESS: With RS485, number that identifies the controller in the communication between 1 and 247.





ALARM CYCLE

FuA 1 FuA 2	(Function of Alarm) – ALARM FUNCTION: Defines the alarm functions according to options shown in Table 3. oFF, IErr, rS, rFR IL, La, H I, d IFL, d IFH, d IF
bLA 1 bLA 2	(blocking for Alarms) - ALARM INITIAL BLOCKING: Alarm initial blocking function for alarms 1 to 4 YES enables initial blocking NO disables initial blocking
HYA 1 HYA 2	(Hysteresis of Alarms) – ALARMS HYSTEREIS: Defines the differential range between the PV value at which the alarm is turned on and the value at which it is turned off. One hysteresis value is set for each alarm.
A It 1	(Alarm 1 time 1) – ALARM 1 TIME 1: Defines the period, in seconds, in which the alarm output will be on when alarm 1 is activated. Set zero to disable this function.
A It 2	(Alarm 1 time 2) – ALARM 1 TIME 2: Defines the period in which alarm 1 will be off after being activated. Set zero to disable this function.
A 2t 1	(Alarm 2 time 1) – ALARM 2 TIME 1: Defines the period, in seconds, in which the alarm output will be on when alarm 2 is activated. Set zero to disable this function.
A 2t 2	(Alarm 1 time 2) – ALARM 2 TIME 2: Defines the period in which alarm 2 will be off after being activated. Set zero to disable this function. Table 4 shows the advanced functions one can obtain with timer.

INPUT CONFIGURATION CYCLE

tYPE	(tYPE) – TYPE OF INPUT: Selection of the type of signal connected to the PV input. See Table 1. This must be the first parameter to be set up.
dPPo	(decimal Point Position) – DECIMAL POINT POSITION: Only for inputs 16, 17, 18 and 19. Determines the position of the decimal point in all parameters related to PV and SP.
un i t	(unit) - TEMPERATURE: Selects the temperature unit: Celsius ("°C") or Fahrenheit ("°F"). Not valid for inputs 16, 17, 18 and 19.
oFFS	(oFFSet) - OFFSET for PV: Offset value to be added to the PV to compensate sensor error. Default value: zero. Adjustable between -400 and +400.
SPLL	(SetPoint Low Limit) - SETPOINT LOW LIMIT: For linear inputs, selects the minimum value of indication and adjustment for parameters related to PV and SP. For thermocouples and Pt100, selects the minimum value for SP adjustment. Defines also the lower limit value for retransmission of PV and SP.

I/O CYCLE (INPUTS AND OUTPUTS)

i o 1	I/O 1 FUNCTION: Selects the I/O function to be used at I/O 1. Options 0 to 5 are possible for this output. Refer to the IO Channels Configuration item for details.
i o 2	I/O 2 FUNCTION: Selects the I/O function to be used at I/O 2. Options 0 to 5 are possible for this output. Refer to the IO Channels Configuration item for details.
i o 3	I/O 3 FUNCTION: Selects the I/O function to be used at I/O 3. Options 0 to 5 are possible for this output. Refer to the IO Channels Configuration item for details.
i o 4	I/O 4 FUNCTION: Selects the I/O function to be used at I/O 4. Options 0 to 5 are possible for this output. Refer to the IO Channels Configuration item for details.
i o 5	(input/output 5) - I/O 5 FUNCTION: Selects the I/O function to be used at I/O 5. Options 0 to 16 are available. Usually employed in analog control or retransmission. Refer to the IO Channels Configuration item for details.
i o 6	I/O 6 FUNCTION: Selects the I/O function to be used at I/O 6 (Digital Input). Options 0, 7, 8, 9 and 10 are possible for this input. Refer to the IO Channels Configuration item for details.
FFunc	F Key function – Allows definition of the F key function. Available functions: 0 - Key not used; 7 - Controls output and alarm outputs (RUN function) 8 - Invalid selection; 9 - Halt program execution; i0 - Selects program 1; These functions are described in item 4.2.
AE n	Enable the  key – Allows the user to enable the  key or not, so that the user can quickly switch from automatic to manual control. YES Enables  no Disables 

CALLIBRATION CYCLE

All input and output types are factory calibrated. Recalibration is not recommended. If necessary, recalibration must be performed by specialized personnel. If this cycle is accessed by mistake, do not press \uparrow or \downarrow keys, go all through the prompts up to the operation cycle is reached again.

InLE	(input Low Calibration) – INPUT OFFSET CALIBRATION: Makes possible to calibrate the PV offset. To change one digit, press \uparrow or \downarrow as many times as necessary.
InHE	(input High Calibration) – INPUT SPAN CALIBRATION (gain): Makes possible to calibrate the PV offset.
ouLL	(output Low Calibration) – OUTPUT LOW CALIBRATION: Value for current output low calibration (offset).
ouHE	(output High Calibration) – OUTPUT HIGH CALIBRATION: Value for current output high calibration.
[J] L	COLD JUNCTION OFFSET CALIBRATION: Sets the cold junction offset calibration.
PotL	POTENTIOMETER LOW CALIBRATION. To change one digit, press \uparrow and \downarrow as many times as necessary.
PotH	POTENTIOMETER HIGH CALIBRATION – End of scale calibration of the potentiometer.

RAMP AND SOAK PROGRAM

This feature allows for the elaboration of a behavior profile for the process. Each program is composed of a set of up to **7 segments**, named RAMP AND SOAK PROGRAM, defined by SP values and time intervals.

When the program is defined and runs, the controller starts to automatically generate the SP according to the program.

At the end of the program execution, the controller turns the control output off (**run**= no).

Up to **7 different programs** of ramp and soak can be created. The figure below shows an example of the program:

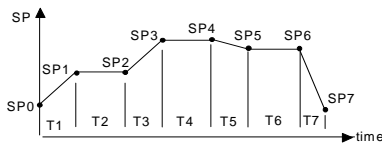

Figure 8 – Example of the ramp and soak program.

To execute a profile with fewer segments, set 0 (zero) for the time intervals that follow the last segment to be executed.

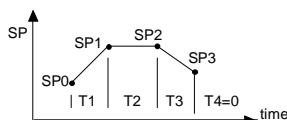

Figure 9 – Example of a program with a few segments

The tolerance function of the **Ptol** defines the maximum deviation between PV and SP during the program execution. If this deviation is exceeded, the program will be interrupted until the deviation falls within the tolerance range (regardless of time). Programming 0 (zero) at this prompt disables the tolerance; the profile execution will not be halted even if PV does not follow SP (only considers time).

LINK OF PROGRAMS

It is possible to create a more complex program, with up to 49 segments, joining the seven programs. This way, at the end of a program execution the controller immediately starts to run another one.

When a program is created, it must be defined in the **LP** screen whether there will be or not another program.

To make the controller run a given program or many programs continuously, it is only necessary to link a program to itself or the last program to the first.

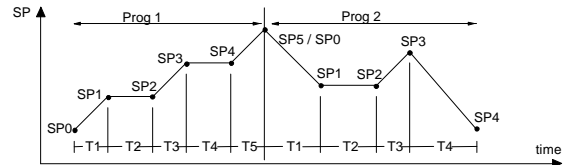

Figure 10 – Example program 1 and 2 linked (interconnected).

EVENT ALARM

This function makes possible to program the activation of alarms in specific segments of a program.

For such, alarms must have their function set as **rS** and be programmed in **PE i** to **PE 7** according to Table 6. The number programmed in the event prompt defines the alarms to be activated.

CODE	ALARM 1	ALARM 2
0		
1	X	
2		X
3	X	X

Table 6 – Event values for ramps and soaks

In order to configure a ramp and soak program:

- Tolerance values, SPs, time and event should be programmed.
- If an alarm will be used with the event function, set up its function to Event Alarm.
- Set control mode to automatic.
- Enable program execution in **rS** screen.
- Start the control at the **run** prompt.

Before executing the program the controller waits for PV to reach the initial setpoint (**SP0**). Should any power failure occur the controller resumes at the beginning of the segment it was running.

AUTO TUNING OF PID PARAMETERS

During auto tune the process is controlled in ON / OFF mode at the programmed SP. Depending on the process features, large oscillations above and below SP may occur. Auto tune may take several minutes to be concluded in some processes.

The recommended procedure is as it follows:

- Disable the control output at the **run** prompt.
- Select auto mode operation at the **Auto** prompt.
- Select a value different from zero for the proportional band.
- Disable the soft-start function
- Disable the ramp and soak function and program a new PV value other than the present PV (close to the desired set point).
- Enable auto tuning at the **Auto** prompt.
- Enable the control at the **run** screen.

During the auto tune procedure the TUNE indication will remain on.

For the control output with relays or current pulse, automatic tune calculates the highest possible value for the PWM period. This value can be reduced in cases of low instability. For a relay of solid state, reduction to 1 second is recommended.

If the automatic tune does not result a satisfactory control, refer to Table 7 for manual fine tuning procedure.

PARAMETER	PROBLEM	SOLUTION
Proportional band	Slow response	Decrease
	Large oscillation	Increase
Integral rate	Slow response	Increase
	Large oscillation	Decrease
Derivative time	Slow response or instability	Decrease
	Large oscillation	Increase

Table 7 – Suggestions for manual tuning of PID parameters

CALIBRATION

INPUT CALIBRATION

All input and output types are factory calibrated. Recalibration is not recommended for operators with no experience. In case recalibration of any scale is necessary, proceed as it follows:

- Set up the input type to be calibrated
- Set the lower and upper limits of extreme values for the input type
- Apply a signal to the input that corresponds to a known value and a little bit over the lower limit of the indication.
- Access the "**inLc**" parameter. By using the \blacktriangle and \blacktriangledown keys select the expected value that will appear in the parameters display.
- Apply a signal to the input that corresponds to a known value and a little bit under the lower limit of the indication.
- Access the "**inLc**" parameter. By using the \blacktriangle and \blacktriangledown keys select the expected value that will appear in the parameters display.
- Repeat c to f up to no new adjustment is necessary.

Note: When the controller is calibrated, check if the required excitation current of Pt100 is compliant to the Pt100 excitation current used in this instrument. 0.17 mA.

ANALOG OUTPUT CALIBRATION

- Configure I/O 5 for 11 (0-20 mA) or 12 (4-20 mA) values.
- Connect a mA meter in the analog control output.
- Disable auto-tune and soft-start.
- Program the lower limit of MV in the "**ouLL**" prompt with 0.0 % and the upper limit of MV in the "**ouHL**" with **100.0**.
- Set "**no**" for the manual mode "**Auto**" prompt.
- Enable the control (**YES**) at the "**run**" prompt.
- Program MV in 0.0 % in the operation cycle.
- Select the "**ouLc**" prompt. Use the \blacktriangle and \blacktriangledown keys to obtain the 0 mA (or 4 mA for type 12) reading in the mA meter.
- Program MV in 100.0 % in the operation cycle.
- Select the "**ouHc**" prompt. Use the \blacktriangle and \blacktriangledown keys to obtain the 20 mA.
- Repeat 7 to 10 up to no new adjustment is necessary.

POTENTIOMETER CALIBRATION

- Set up the input type to be calibrated
- Set the lower and upper limits of indication for the extremes of the input type
- Adjust the potentiometer with the minimum value.
- Access the "**PotL**" parameter. By using the \blacktriangle and \blacktriangledown keys select 0.0 in the parameters display.
- Adjust the potentiometer with the maximum value.
- Access the "**PotH**" parameter. By using the \blacktriangle and \blacktriangledown keys select 100.0 in the parameters display.
- Repeat c to f up to no new adjustment is necessary.

SERIAL COMMUNICATION

An optional master-slave RS485 serial communication interface is available. It is used for communication with a supervisor machine (master). The controller is always the slave.

Communication starts only with the master, which sends a command to the slave address with which it wants to communicate. The slave takes the command and sends the correspondent response to the master.

The controller accepts also broadcast commands.

FEATURES

Signals compliant to the RS-485 standard. Two-wire connection between the master and up to 31 instruments in bus topology (it may address up to 247 instruments). Maximum cable length: 1,000 meters. Time to disconnect from the controller. Maximum 2ms after the last byte.

Communication signals are electrically isolated from the rest of the device, speed options are 1200, 2400, 4800, 9600 or 19200 bps.

Number of data bits: 8, without parity

Number of stop bits: 1

Time of response transmission start: Maximum 100ms after receiving the command.

Protocol used: MODBUS (RTU), available in most market-available supervisory software.

RS-485 signals are:

D1 = D: Bidirectional data line

D0 = \bar{D} : Inverted bidirectional data line

C = GND: Optional connection to improve communication performance

COMMUNICATION PARAMETERS CONFIGURATION

Two parameters must be configured for serial use:

bAud: Communication speed. All equipments with the same speed.

Addr: Controller communication address. Each controller must have an exclusive address.

PROBLEMS WITH THE CONTROLLER

Connection errors and inadequate programming are the most common errors found during the controller operation. A final review may avoid loss of time and damages.

The controller displays some messages to help the user identify problems.

MESSAGE	PROBLEM
----	Open input. Without sensor or signal.
Err i	Connection problems in the Pt100 cable

Other error messages displayed by the controller can account for errors in the input connections or type of selected input non compliant with the sensor or signal applied to the input. If errors persist, even after a review, contact the manufacturer. Inform also the device serial number. To find out the serial number, press \square for more than 3 seconds.

The controller also has a visual alarm (the display flashes) when the PV value is out of the range set by **SPHL** and **SPLL**.

ORDERING INFORMATION:

N2000S -	485 -	24V
A	B	C

A: Series model: **N2000S**

B: Digital communication: **blank**
485 (RS485, Modbus protocol)

C: Voltage rating: **blank** (100 to 240 Vac)
24V (24 Vdc/ac)

SPECIFICATIONS

INPUT Keyboard selection of input type (refer to **Table 1**)
 Internal resolution: 19500 levels
 Display resolution: 12000 levels (from -1999 to 9999)
 Input sample rate: 5 per second
 Accuracy: Thermocouples J, K and T: 0.25 % of span ± 1 °C
 Thermocouple N, R, S: 0.25 % of span ± 3 °C
 Pt100: 0.2 % of span
 4-20 mA, 0-50 mV, 0-5 Vdc: 0.2 % of span.
 Input impedance: ... 0-50 mV, Pt100 and thermocouples: >10 M Ω
 0-5 V: >1 M Ω
 4-20 mA: 15 Ω (+2 Vdc @ 20 mA)
 Pt100 measurement: standard ($\alpha=0.00385$)
 Excitation current: 0.170 mA
 3-wire circuit, cable resistance compensation
 All input types are factory calibrated according to IEC-584 for
 Thermocouples and IEC-751 for Pt100

DIGITAL INPUT (I/O6): Dry contact or NPN open collector

ANALOG OUTPUT (I/O5): 0-20 mA or 4-20 mA, 550 Ω max.
 1500 levels, Isolated
 Control output or PV or SP retransmission

CONTROL OUTPUT:
 2 Relays SPDT (I/O1 and I/O2): 3 A / 240 Vac
 2 Relays SPST-NO (I/O3 and I/O4): 1.5 A / 250 Vac
 Logic pulse for SSR drive (I/O5): 10 V max / 20 mA

This feature requires an external shunt resistor, provided with the instrument, to be connected to terminals 19 and 20.

DIMENSIONS: 48 x 96 x 92 mm (1/16 DIN).
 Approximate weight: 150 g

PANEL CUT-OUT: 45 x 93 mm (+0.5 -0.0 mm)

TERMINAL CONNECTION: 24 screws accepting 6.3 mm fork lugs

POWER: 100 to 240 Vac/dc (± 10 %), 50/60 Hz.
 Optional: 24 Vac/dc ± 10 %
 Max. Consumption: 9 VA

ENVIRONMENTAL CONDITIONS: 5 to 50 °C
 Relative humidity (maximum): 80 % up to 30 °C.
 For temperatures above 30 °C, decrease 3 % per °C.
 Installation category II. Pollution degree 2. Altitude < 2000 m

EMC EN 61326-1:1997 and EN 61326-1/A1:1998

SAFETY: EN61010-1:1993 and EN61010-1/A2:1995

PROGRAMMABLE PWM CYCLE FROM 0.5 SEC. AND 100 SEC.;
START UP 3 SECONDS AFTER POWER UP;

WARRANTY

This product is covered by a 12-month warranty provided the purchaser presents the sales receipt and the following conditions are met:

- Products are covered for one year from the original date of purchase. Please retain the dated sales receipt as evidence of the date of purchase. You will need it for any warranty service
- Within this period, warranty against defects in material and workmanship under normal use is free of charge.
- For repair, send the product and the sales receipt to our address. Expenses and transportation risks are under the purchaser's responsibility.
- This warranty does not cover any damage due to accident, misuse, abuse, or negligence.